



# Pohištveni ročaji in obešalniki

**STARMAN**<sup>®</sup>

So ljudje, ki dajo lesu še lepšo obliko in podobo,  
in smo ljudje, ki jim pri tem pomagamo in svetujemo.<sup>®</sup>



# STARMAN<sup>®</sup>

## VSE ZA MIZARJE NA ENEM MESTU

### POMAGAMO IN SVETUJEMO PRI IZBIRI

Osnovna dejavnost podjetja Starman d.o.o. je veleprodaja kovinskega programa (pohištveno okovje, vijaki, LED luči, stavbno okovje ...) in lesnega programa (iverne plošče, laminati, MDF plošče, delovne plošče, ultrapasji, kompaktni plošče, akrilne plošče ...) in orodij ter ostalih repromaterialov za potrebe lesne industrije in obrti ter blaga široke potrošnje za trgovine.

Veleprodajni program obsega preko 23.000 različnih izdelkov, katere dobavlja preko 120 tujih in 90 domačih dobaviteljev. Pri izbiri dobaviteljev upoštevamo različne kriterije, upoštevamo pa tudi kriterije, ki so določeni v ISO standardu.

Blago iz veleprodajnega programa STARMAN d.o.o. prodajamo na celotnem slovenskem trgu ter izvažamo na tuje trge, predvsem v Hrvaško, Bosno in Hercegovino, Črno goro, Makedonijo in Srbijo.

Od marca 2008 imamo delovni proces certificiran po standardu ISO 9001:2008. Proizvodi iz lesnega prodajnega programa so v zelo veliki večini certificirani s certifikatom PEFC™, na željo stranke pa lahko po naročilu zagotovimo tudi certifikat FSC®.

### ODPIRALNI ČAS VELEPRODAJE:

pon. - čet.: 7.30 - 14.30

pet.: 7.30 - 12.00

sobote, nedelje in prazniki: zaprto

### KONTAKT:

Starman d.o.o.

Poslovna cona Žeje pri Komendi

Pod brezami 2, 1218 Komenda









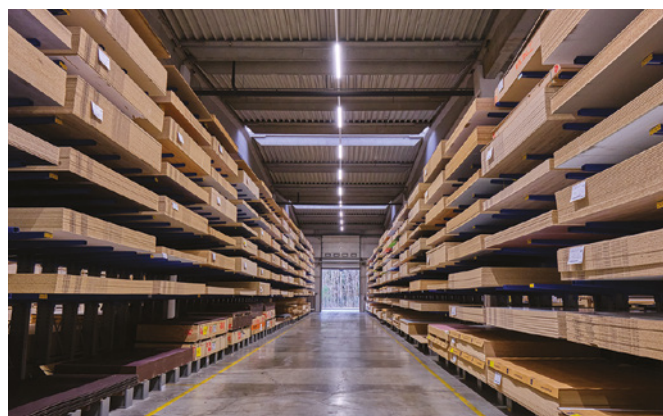



tel: +386 (0)1 724 79 00

e-mail: [info@starman.si](mailto:info@starman.si)

[www.starman.si](http://www.starman.si)

***“So ljudje, ki dajejo lesu še lepšo obliko in podobo, in smo ljudje, ki jim pri tem pomagamo in svetujemo.”***



	<b>Str.</b>
 <b>Pohištveni ročaji</b> .....	<b>1 - 34</b>
 Dvovijačni pohištveni ročaji .....	1 - 15
 Enovijačni pohištveni ročaji .....	16 - 17
 Utopni pohištveni ročaji .....	18 - 20
 Brezvijačni pohištveni ročaji .....	21
 Dolgi aluminijasti ročaji .....	22
 Aluminijasti profili .....	23 - 32
 Ročaji za drsna vrata .....	33 - 34
 <b>Pohištveni obešalniki</b> .....	<b>35 - 43</b>
 Samolepilni obešalniki .....	44
 Nosilci za toaletni papir .....	45
 <b>Ročaji za ograje</b> .....	<b>46 - 48</b>

# VODIČ BARV

## ČRNA

Črna barva je klasična izbira v svetu pohištva, ki prinaša eleganco in prefinjenost v vsak prostor. Črni pohištveni ročaji in obešalniki se odlično podajo k sodobnim in minimalističnim dizajnom, kjer želimo ustvariti kontrast in poudariti čistost linij. Črna barva je zelo vsestranska in se zlahka kombinira z različnimi materiali, kot so les, steklo ali kovina, kar omogoča nešteto možnosti pri oblikovanju notranjosti. Poleg tega črni ročaji in obešalniki delujejo zelo sofisticirano in lahko dodajo pridih luksuza tudi najbolj preprostim kosom pohištva.



## KROM

Krom je priljubljena izbira zaradi svojega sijajnega in zrcalnega videza, ki prostoru doda občutek modernosti in prefinjenosti. Kromirani pohištveni ročaji in obešalniki so znani po svoji vzdržljivosti in odpornosti na obrabo, kar jih naredi idealne za pogosto uporabljene prostore, kot so kuhinje in kopalnice. Sijajna površina kroma odseva svetlobo, kar lahko pripomore k optičnemu povečanju prostora in dodajanju svetlosti. Kromirani ročaji in obešalniki se odlično podajo k sodobnim in industrijskim stilom, hkrati pa se zlahka kombinirajo z drugimi kovinskimi elementi v prostoru.



## ZLATA

Zlata barva v pohištvu izžareva razkošje, toplino in eleganco. Zlati pohištveni ročaji in obešalniki so kot nalašč za tiste, ki želijo v svoj dom vnesti pridih prestiža in klasičnega šarma. Zlata barva se lepo poda k bogatim tonom lesa in temnim barvam, kar ustvarja občutek razkošja in ugodja. Poleg tega lahko zlati ročaji in obešalniki delujejo kot osrednji dekorativni elementi, ki pritegnejo pozornost in dodajo vrednost celotnemu prostoru. Pri uporabi zlate barve je pomembno, da se upošteva ravnotežje, saj lahko prekomerna uporaba privede do pretiranega in kičastega videza.





## POHIŠTVENI ROČAJI

Naš asortiman ponuja širok nabor pohištvenih ročajev v različnih materialih in barvah, primernih za vsak okus in stil. Izbirate lahko med dvovijačnimi, enovijačnimi, brezvijačnimi in utopnimi ročaji.

Pohištveni ročaji vašemu pohištvu dodajo funkcionalnost in dekorativno noto. Poskrbijo za tisto piko na i, ki poudari vaš osebni stil in ustvari želeni videz prostora. Z njimi lahko dosežete eleganten, rustikalen ali sodoben ambient. Izdelani so iz vrhunskih materialov, zato imajo ročaji dolgo življenjsko dobo in omogočajo trajno zadovoljstvo. Sodelujemo z vodilnimi priznanimi znamkami na področju pohištvenih ročajev, kar zagotavlja kakovost in zanesljivost naših izdelkov.

---

### ZNAMKE





## DVOVIJAČNI POHIŠTVENI ROČAJI

Pri izbiri dvovijačnih pohištvenih ročajev, bodite še posebej pozorni na razmik med luknjami. Pomembno je, da je dimenzija ročajev proporcionalna z dimenzijo vrat. Dimenzije med vijaki, se običajno stopnjujejo po 32 ali 64 mm. Pri izbiri ročajev pa je poleg videza in proporcionalnosti zelo pomembna tudi praktičnost. Za večja vrata je priporočljiva izbira daljših ročajev za katere lahko zlahka zatakne štiri prste, kar nam omogoča, da vrata odpiramo z večjo silo.

### POHIŠTVENI ROČAJ ALUMINIJ

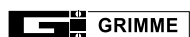

Šifra	Naziv	Obdelava	Dolžina mm	Širina mm	Razmik mm	Višina mm
390000	08 5714 46.19	izgled inoxa	135	19	128	30



### POHIŠTVENI ROČAJ ALUMINIJ

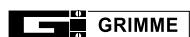

Šifra	Naziv	Obdelava	Dolžina mm	Širina mm	Razmik mm	Višina mm
390002	08 6574 46.28	izgled brušenega inoxa	160	14	128	24
390003	08 6574 46.27	mat nikelj	160	14	128	24



### POHIŠTVENI ROČAJ ALUMINIJ

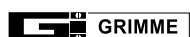

Šifra	Naziv	Obdelava	Dolžina mm	Širina mm	Razmik mm	Višina mm
390014	08 5114 46.30	mat krom	159	17	128	27



### POHIŠTVENI ROČAJ ZAMAK

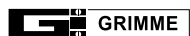

Šifra	Naziv	Obdelava	Dolžina mm	Širina mm	Razmik mm	Višina mm
390017	08 7444 19	izgled inoxa	152	20	128	25





## POHIŠTVENI ROČAJ ALUMINIJ

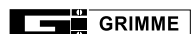

Šifra	Naziv	Obdelava	Dolžina mm	Širina mm	Razmik mm	Višina mm
390020	08 8469 46.31	mat krom lakirana	155	8	128	26

## POHIŠTVENI ROČAJ ALUMINIJ

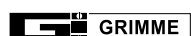

Šifra	Naziv	Obdelava	Dolžina mm	Širina mm	Razmik mm	Višina mm
390031	08 5945 46.19	izgled inoxa	180	19	160	26
390033	08 5945 30.1	mat krom	180	19	160	26

## POHIŠTVENI ROČAJ ALUMINIJ

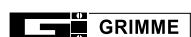

Šifra	Naziv	Obdelava	Dolžina mm	Širina mm	Razmik mm	Višina mm
390034	08 6425 46.19	izgled inoxa	168	20	160	26

## POHIŠTVENI ROČAJ ALUMINIJ



Šifra	Naziv	Obdelava	Dolžina mm	Širina mm	Razmik mm	Višina mm
390038	08 8750 46.19	izgled inoxa	202	29	160	26
390039	08 8750 46.31	mat krom lakirana	202	29	160	26

## POHIŠTVENI ROČAJ ALUMINIJ



Šifra	Naziv	Obdelava	Dolžina mm	Širina mm	Razmik mm	Višina mm
390051	08 6525 46.19	izgled inoxa	168	23	160	28
390053	08 6525 46.31	mat krom lakirana	168	23	160	28



## POHIŠTVENI ROČAJ ALUMINIJ

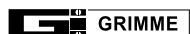

Šifra	Naziv	Obdelava	Dolžina mm	Širina mm	Razmik mm	Višina mm
390068	08 6345 46.19	izgled inoxa	195	24	160	27
390069	08 6349 46.31.1	mat krom lakirana	195	24	160	27

## POHIŠTVENI ROČAJ ALUMINIJ

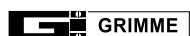

Šifra	Naziv	Obdelava	Dolžina mm	Širina mm	Razmik mm	Višina mm
390076	08 8450 46.30	mat krom	160	22	128	28
390077	08 8451 46.19	izgled inoxa	192	22	160	28
390078	08 8451 46.30	mat krom	192	22	160	28

## POHIŠTVENI ROČAJ ALUMINIJ

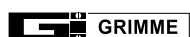

Šifra	Naziv	Obdelava	Dolžina mm	Širina mm	Razmik mm	Višina mm
390079	08 9484 46.19	izgled inoxa	202	25	160	27

## POHIŠTVENI ROČAJ ALUMINIJ



Šifra	Naziv	Obdelava	Dolžina mm	Širina mm	Razmik mm	Višina mm
391166	08 3220 16	črna	260	8	192	32

## POHIŠTVENI ROČAJ ALUMINIJ

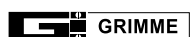

Šifra	Naziv	Obdelava	Dolžina mm	Širina mm	Razmik mm	Višina mm
391208	08 5304 46.16	črna mat	170	10	160	27
391211	08 5304 46.24	zlata mat	170	10	160	27
391209	08 5305 46.16	črna mat	202	10	192	27
391212	08 5305 46.24	zlata mat	202	10	192	27
391210	08 5307 46.16	črna mat	266	10	256	27
391213	08 5307 46.24	zlata mat	266	10	256	27





## POHIŠTVENI ROČAJ ALUMINIJ

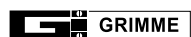

Šifra	Naziv	Obdelava	Dolžina mm	Širina mm	Razmik mm	Višina mm
391042	08 5372 46.16	črna mat	106	10	96	30
391043	08 5373 46.16	črna mat	138	10	128	30
391044	08 5374 46.16	črna mat	170	10	160	30
391045	08 5375 46.16	črna mat	202	10	192	30
391046	08 5378 46.16	črna mat	330	10	320	30

## POHIŠTVENI ROČAJ ALUMINIJ

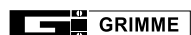

Šifra	Naziv	Obdelava	Dolžina mm	Širina mm	Razmik mm	Višina mm
391047	08 5392 46.16	črna mat	162	12	96	27
391048	08 5393 46.16	črna mat	194	12	128	27
391049	08 5394 46.16	črna mat	226	12	160	27
391050	08 5395 46.16	črna mat	258	12	192	27
391051	08 5396 46.16	črna mat	386	12	320	27

## POHIŠTVENI ROČAJ ALUMINIJ

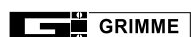

Šifra	Naziv	Obdelava	Dolžina mm	Širina mm	Razmik mm	Višina mm
391190	08 7629 16	črna mat brušena	168	25	160	30
391192	08 7629 36	zlata mat brušena	168	25	160	30
391191	08 7630 16	črna mat brušena	328	25	320	30
391193	08 7630 36	zlata mat brušena	328	25	320	30

## POHIŠTVENI ROČAJ ALUMINIJ

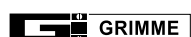

Šifra	Naziv	Obdelava	Dolžina mm	Širina mm	Razmik mm	Višina mm
391202	08 7666 46.16	črna mat	198	9	160	26
391205	08 7666 46.24	zlata mat	198	9	160	26
391203	08 7667 46.16	črna mat	230	9	192	28
391206	08 7667 46.24	zlata mat	230	9	192	28
391204	08 7668 46.16	črna mat	363	9	320	29
391207	08 7668 46.24	zlata mat	363	9	320	29

## POHIŠTVENI ROČAJ ZAMAK

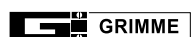

Šifra	Naziv	Obdelava	Dolžina mm	Širina mm	Razmik mm	Višina mm
390547	73 7065 22	staran antik mat	152	19	128	26



## POHIŠTVENI ROČAJ ALUMINIJ

**GRIMME**



Šifra	Naziv	Obdelava	Dolžina mm	Širina mm	Razmik mm	Višina mm
391038	08 5312 46.16	črna mat	116	16	96	25
391230	08 5312 46.23	zlata brušena	116	16	96	25
391234	08 5312 46.80	sateno siva	116	16	96	25
391039	08 5313 46.16	črna mat	148	16	128	25
391231	08 5313 46.23	zlata brušena	148	16	128	25
391236	08 5313 46.80	sateno siva	148	16	128	25
391040	08 5314 46.16	črna mat	180	16	160	25
391232	08 5314 46.23	zlata brušena	180	16	160	25
391235	08 5314 46.80	sateno siva	180	16	160	25
391041	08 5315 46.16	črna mat	212	16	192	25
391233	08 5315 46.23	zlata brušena	212	16	192	25
391237	08 5315 46.80	sateno siva	212	16	192	25

## POHIŠTVENI ROČAJ INOX

**GRIMME**



Šifra	Naziv	Obdelava	Dolžina mm	Širina mm	Razmik mm	Višina mm
390100	08 2003 20.12	inox satenirana	108	12	96	35
390101	08 2004 20.12	inox satenirana	140	12	128	35
390102	08 2005 20.12	inox satenirana	172	12	160	35
390103	08 2006 20.12	inox satenirana	204	12	192	35
390104	08 2009 20.12	inox satenirana	300	12	288	35
390105	08 2010 20.12	inox satenirana	332	12	320	35
390106	08 2012 20.12	inox satenirana	386	12	384	35
390107	08 2015 20.12	inox satenirana	492	12	480	35
390108	08 2023 20.12	inox satenirana	748	12	736	35

## POHIŠTVENI ROČAJ INOX

**GRIMME**



Šifra	Naziv	Obdelava	Dolžina mm	Širina mm	Razmik mm	Višina mm
390120	IN 0121 0096.1	inox satenirana	118	12	96	34
390122	IN 0121 0160.1	inox satenirana	182	12	160	34
390123	IN 0121 0192.1	inox satenirana	214	12	192	34
390124	IN 0121 0224.1	inox satenirana	246	12	224	34
390125	IN 0121 0288.1	inox satenirana	310	12	288	34
390126	IN 0121 0320.1	inox satenirana	342	12	320	34
390127	IN 0121 0352.1	inox satenirana	374	12	352	34
390128	IN 0121 0448.1	inox satenirana	470	12	448	34
390196	IN 0121 0480.1	inox satenirana	502	12	480	34



## POHIŠTVENI ROČAJ INOX

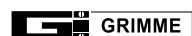

Šifra	Naziv	Obdelava	Dolžina mm	Širina mm	Razmik mm	Višina mm
390129	85 1221 0096	inox brušena	176	14	96	35
390130	85 1221 0128	inox brušena	208	14	128	35
390131	85 1221 0160	inox brušena	240	14	160	35
390132	85 1221 0192	inox brušena	272	14	192	35
390133	85 1221 0224	inox brušena	304	14	224	35
390134	85 1221 0288	inox brušena	368	14	288	35
390135	85 1221 0320	inox brušena	400	14	320	35
390136	85 1221 0384	inox brušena	464	14	384	35
390137	85 1221 0480	inox brušena	560	14	480	35
390138	85 1221 0576	inox brušena	656	14	576	35
390139	85 1221 0640	inox brušena	720	14	640	35

## POHIŠTVENI ROČAJ INOX

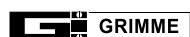

Šifra	Naziv	Obdelava	Dolžina mm	Širina mm	Razmik mm	Višina mm
390536	85 1421 0096	inox brušena	176	12	96	33
390537	85 1421 0128	inox brušena	208	12	128	33
390538	85 1421 0160	inox brušena	240	12	160	33
390539	85 1421 0192	inox brušena	272	12	192	33
390540	85 1421 0224	inox brušena	304	12	224	33
390541	85 1421 0288	inox brušena	368	12	288	33
390542	85 1421 0320	inox brušena	400	12	320	33
390543	85 1421 0480	inox brušena	560	12	480	33
390544	85 1421 0640	inox brušena	720	12	640	33

## POHIŠTVENI ROČAJ ALUMINIJ

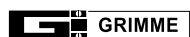

Šifra	Naziv	Obdelava	Dolžina mm	Širina mm	Razmik mm	Višina mm
390235	08 3703 47.2	barva aluminija	156	12	96	32
390236	08 3704 47.2	barva aluminija	188	12	128	32
390237	08 3705 47.2	barva aluminija	220	12	160	32
390238	08 3706 47.2	barva aluminija	252	12	192	32
390239	08 3707 47.2	barva aluminija	284	12	224	32
390240	08 3710 47.2	barva aluminija	380	12	320	32
390241	08 3752 47.2	barva aluminija	540	12	480	32
390242	08 3766 47.2	barva aluminija	700	12	640	32



## POHIŠTVENI ROČAJ ALUMINIJ

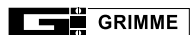

Šifra	Naziv	Obdelava	Dolžina mm	Širina mm	Razmik mm	Višina mm
390216	08 3321 47.1	barva aluminija	82	12	64	34
390217	08 3323 47.1	barva aluminija	114	12	96	34
390218	08 3324 47.1	barva aluminija	146	12	128	34
390219	08 3325 47.1	barva aluminija	178	12	160	34
390220	08 3326 47.1	barva aluminija	210	12	192	34
390221	08 3330 47.1	barva aluminija	338	12	320	34
390222	08 3335 47.1	barva aluminija	498	12	480	34
390223*	08 3343 47.1	barva aluminija	786	12	768	34
390224*	08 3345 47.1	barva aluminija	818	12	800	34

### LASTNOSTI:

\* na sredini dodatna nogica zaradi večjega razmika med luknjami.  
(ročaj ima 3 nogice)

## POHIŠTVENI ROČAJ INOX

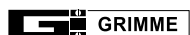

Šifra	Naziv	Obdelava	Dolžina mm	Širina mm	Razmik mm	Višina mm
391107	IN 0226 0128	črna	150	12	128	34
391108	IN 0226 0160	črna	182	12	160	34
391109	IN 0226 0192	črna	214	12	192	34
391110	IN 0226 0320	črna	342	12	320	34
391111	IN 0226 0480	črna	502	12	480	34

## POHIŠTVENI ROČAJ JEKLO

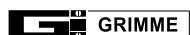

Šifra	Naziv	Obdelava	Dolžina mm	Širina mm	Razmik mm	Višina mm
390577	85 2526 0128	črna	188	12	128	32
390578	85 2526 0160	črna	220	12	160	32
390579	85 2526 0192	črna	252	12	192	32
390580	85 2526 0320	črna	380	12	320	32

## POHIŠTVENI ROČAJ ZAMAK

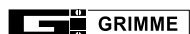

Šifra	Naziv	Obdelava	Dolžina mm	Širina mm	Razmik mm	Višina mm
390362	08 6344 19	izgled inoxa	163	24	128	25
390363	08 6344 30	mat krom	163	24	128	25
390364	08 6347 19	izgled inoxa	227	24	192	25
390365	08 6347 30	mat krom	227	24	192	25



## POHIŠTVENI ROČAJ ALUMINIJ

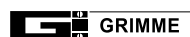

Šifra	Naziv	Obdelava	Dolžina mm	Širina mm	Razmik mm	Višina mm
390256	08 8725 46.1	izgled brušenega inoxa	172	16	160	36
390257	08 8726 46.1	izgled brušenega inoxa	204	16	192	36
390258	08 8727 46.1	izgled brušenega inoxa	268	16	256	36
390259	08 8729 46.1	izgled brušenega inoxa	332	16	320	36
390260	08 8733 46.1	izgled brušenega inoxa	460	16	448	36
390261	08 8740 46.1	izgled brušenega inoxa	780	16	768	36

## POHIŠTVENI ROČAJ ALUMINIJ



Šifra	Naziv	Obdelava	Dolžina mm	Širina mm	Razmik mm	Višina mm
390202	08 6945 31.31	mat krom lakirana	170	20	160	33
390203	08 6949 31.31	mat krom lakirana	202	20	192	33
390204	08 6955 31.31	mat krom lakirana	490	20	480	33

## POHIŠTVENI ROČAJ ALUMINIJ



### LASTNOSTI:

\* ročaji imajo 4 vijačne luknje

Šifra	Naziv	Obdelava	Dolžina mm	Širina mm	Razmik mm	Višina mm
390225	85 3622 0064	barva aluminija	90	8	64	34
390226	85 3622 0150	barva aluminija	190	8	150	34
390227*	85 3642 0200	barva aluminija	240	8	160/200	34
390228	85 3642 0250	barva aluminija	290	8	192/250	34
390229*	85 3642 0300	barva aluminija	340	8	256/300	34
390230*	85 3642 0350	barva aluminija	390	8	320/350	34

## POHIŠTVENI ROČAJ ALUMINIJ



Šifra	Naziv	Obdelava	Dolžina mm	Širina mm	Razmik mm	Višina mm
390209	08 7836 46.28	izgled brušenega inoxa	210	22	192	32
390210	08 7839 46.28	izgled brušenega inoxa	300	22	288	32

## POHIŠTVENI ROČAJ ZAMAK



Šifra	Naziv	Obdelava	Dolžina mm	Širina mm	Razmik mm	Višina mm
390575	72 2390 62	črno nikljana	195	25	160	28



## POHIŠTVENI ROČAJ **ALUMINIJ**

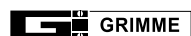

Šifra	Naziv	Obdelava	Dolžina mm	Širina mm	Razmik mm	Višina mm
390266	08 4084 47	barva aluminija	146	20	128	30



## POHIŠTVENI ROČAJ **ZAMAK**

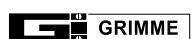

Šifra	Naziv	Obdelava	Dolžina mm	Širina mm	Razmik mm	Višina mm
390589	72 2484 18	izgled mat inoxa	146	19	128	25
390525	72 2486 18	izgled mat inoxa	210	19	192	25
390526	72 2487 18	izgled mat inoxa	338	26	320	25



## POHIŠTVENI ROČAJ **ZAMAK**

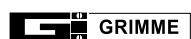

Šifra	Naziv	Obdelava	Dolžina mm	Širina mm	Razmik mm	Višina mm
390546	72 7045 22	staran antik	152	24	128	25



## POHIŠTVENI ROČAJ **ZAMAK**



Šifra	Naziv	Obdelava	Dolžina mm	Širina mm	Razmik mm	Višina mm
390382	72 3722 38	črna antik	158	23	128	34



## POHIŠTVENI ROČAJ **ZAMAK**

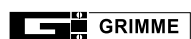

Šifra	Naziv	Obdelava	Dolžina mm	Širina mm	Razmik mm	Višina mm
390570	08 9413 16	črna	104	9	96	28
390571	08 9414 16	črna	136	9	128	28
390572	08 9415 16	črna	168	9	160	28
390573	08 9416 16	črna	200	9	192	28
390574	08 9420 16	črna	328	9	320	28
390548	08 9416 19	izgled inoxa	200	9	192	38





## POHIŠTVENI ROČAJ ALUMINIJ



Šifra	Naziv	Obdelava	Dolžina mm	Širina mm	Razmik mm	Višina mm
391217	08 6866 46.16	črna	150	9	128	27
391218	08 6867 46.16	črna	188	9	160	27
391219	08 6868 46.16	črna	223	9	192	27
391220	08 6869 46.16	črna	240	9	224	27
391221	08 6870 46.16	črna	286	9	256	27
391222	08 6872 46.16	črna	352	9	320	27

## POHIŠTVENI ROČAJ ZAMAK

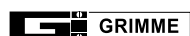

Šifra	Naziv	Obdelava	Dolžina mm	Širina mm	Razmik mm	Višina mm
391223	85 83200 160	bela	168	8	160	28
391224	85 83200 192	bela	200	8	192	28
391225	85 83200 320	bela	328	8	320	28
391226	85 83260 160	črna	168	8	160	28
391227	85 83260 192	črna	200	8	192	28
391228	85 83260 320	črna	328	8	320	28

## POHIŠTVENI ROČAJ ZAMAK



Šifra	Naziv	Obdelava	Dolžina mm	Širina mm	Razmik mm	Višina mm
390527	08 3270 20	izgled temno brušenega inoxa	175	19	160	30
391229	08 3274 20	izgled temno brušenega inoxa	334	19	320	30

## POHIŠTVENI ROČAJ ZAMAK

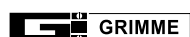

Šifra	Naziv	Obdelava	Dolžina mm	Širina mm	Razmik mm	Višina mm
390528	72 2579 20	izgled temnega inoxa	168	13	128	31
390529	72 2580 20	izgled temnega inoxa	200	13	160	31

## POHIŠTVENI ROČAJ ZAMAK

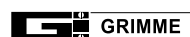

Šifra	Naziv	Obdelava	Dolžina mm	Širina mm	Razmik mm	Višina mm
390530	72 2910 20	izgled temnega inoxa	210	18	160	28
390531	72 2915 20	izgled temnega inoxa	375	19	320	28



## POHIŠTVENI ROČAJ ZAMAK

**GRIMME**



Šifra	Naziv	Obdelava	Dolžina mm	Širina mm	Razmik mm	Višina mm
390532	72 2667 18	izgled mat inoxa	140	10	128	28
390533	72 2668 18	zgled mat inoxa	172	10	160	28
390534	72 2669 18	zgled mat inoxa	268	10	256	28
390535	72 2670 18	zgled mat inoxa	331	10	320	28

## POHIŠTVENI ROČAJ ZAMAK

**GRIMME**



Šifra	Naziv	Obdelava	Dolžina mm	Širina mm	Razmik mm	Višina mm
391054	08 6403 16	črna mat	206	22	160	24
391055	08 6405 16	črna mat	365	22	320	26

## POHIŠTVENI ROČAJ ALUMINIJ

**GRIMME**



Šifra	Naziv	Obdelava	Dolžina mm	Širina mm	Razmik mm	Višina mm
391178	08 7680 16	črna mat	164	26	128	28

## POHIŠTVENI ROČAJ JEKLO

**GRIMME**

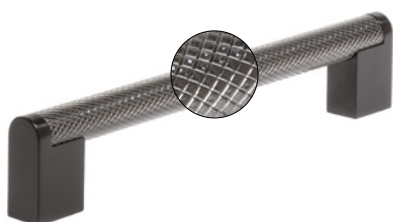

Šifra	Naziv	Obdelava	Dolžina mm	Širina mm	Razmik mm	Višina mm
390582	72 4160 16.45	črna narebričena	188	14	160	36
390583	72 4165 16.45	črna narebričena	348	14	320	36

## POHIŠTVENI ROČAJ ZAMAK

**GRIMME**



Šifra	Naziv	Obdelava	Dolžina mm	Širina mm	Razmik mm	Višina mm
390586	72 2960 46.20	izgled temno brušenega inoxa	208	17	160	28
390587	72 2962 46.20	izgled temno brušenega inoxa	368	18	320	28





## POHIŠTVENI ROČAJ ALUMINIJ

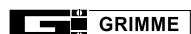

Šifra	Naziv	Obdelava	Dolžina mm	Širina mm	Razmik mm	Višina mm
390584	72 2535 46.20	izgled temnega inoxa	192	19	160	32
390585	72 2538 46.20	izgled temnega inoxa	355	23	320	32

## POHIŠTVENI ROČAJ INOX



Šifra	Naziv	Obdelava	Dolžina mm	Širina mm	Razmik mm	Višina mm
390169	08 8865 17	izgled brušenega inoxa	175	15	160	38
390170	08 8866 17	izgled brušenega inoxa	207	15	192	38
390171	08 8867 17	izgled brušenega inoxa	239	15	224	38
390172	08 8869 17	izgled brušenega inoxa	335	15	320	38
390173	08 8871 17	izgled brušenega inoxa	463	15	448	38
390174	08 8873 17	izgled brušenega inoxa	623	15	608	38
390175	08 8874 17	izgled brušenega inoxa	655	15	640	38

## POHIŠTVENI ROČAJ ALUMINIJ

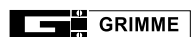

Šifra	Naziv	Obdelava	Dolžina mm	Širina mm	Razmik mm	Višina mm
390262	08 8354 47	barva aluminija	136	20	128	34
390263	08 8355 47	barva aluminija	168	20	160	34
390264	08 8356 47	barva aluminija	200	20	192	34
390265	08 8360 47	barva aluminija	328	20	320	34

## POHIŠTVENI ROČAJ ALUMINIJ

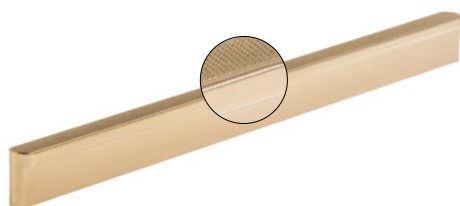
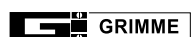

Šifra	Naziv	Obdelava	Dolžina mm	Širina mm	Razmik mm	Višina mm
391180	72 2749 46.16	črno mat eloksirana	150	11	128	20
391184	72 2749 46.24	zlato mat eloksirana	150	11	128	20
391181	72 2750 46.16	črno mat eloksirana	200	11	160	20
391185	72 2750 46.24	zlato mat eloksirana	200	11	160	20
391182	72 2751 46.16	črno mat eloksirana	250	11	192	20
391186	72 2751 46.24	zlato mat eloksirana	250	11	192	20
391183	72 2752 46.16	črno mat eloksirana	400	11	320	20
391187	72 2752 46.24	zlato mat eloksirana	400	11	320	20



## POHIŠTVENI ROČAJ INOX

**GRIMME**



Šifra	Naziv	Obdelava	Dolžina mm	Širina mm	Razmik mm	Višina mm
<b>390155</b>	72 2173 17	inox brušena	115	10	96	32
<b>390156</b>	72 2174 17	inox brušena	152	10	128	32
<b>390157</b>	72 2175 17	inox brušena	187	10	160	32
<b>390158</b>	72 2176 17	inox brušena	224	10	192	32
<b>390159</b>	72 2177 17	inox brušena	263	10	224	32
<b>390160</b>	72 2179 17	inox brušena	335	10	288	32
<b>390161</b>	72 2180 17	inox brušena	372	10	320	32

## POHIŠTVENI ROČAJ JEKLO

**GRIMME**



Šifra	Naziv	Obdelava	Dolžina mm	Širina mm	Razmik mm	Višina mm
<b>125259</b>	72 1393 17	mat krom	115	10	96	30
<b>125302</b>	72 1394 16	črna	151	10	128	30
<b>125301</b>	72 1394 17	mat krom	151	10	128	30
<b>391080</b>	72 1395 16	črna	190	10	160	32
<b>125393</b>	72 1395 17	mat krom	190	10	160	32
<b>391081</b>	72 1396 16	črna	225	10	192	32
<b>125256</b>	72 1396 17	mat krom	225	10	192	32
<b>125252</b>	72 1397 17	mat krom	264	10	224	32
<b>391082</b>	72 1400 16	črna	375	10	320	34

## POHIŠTVENI ROČAJ INOX

**GRIMME**



Šifra	Naziv	Obdelava	Dolžina mm	Širina mm	Razmik mm	Višina mm
<b>390140</b>	72 2142 17	inox brušena	74	10	64	35
<b>390141</b>	72 2143 17	inox brušena	106	10	96	35
<b>390142</b>	72 2144 17	inox brušena	138	10	128	35
<b>390143</b>	72 2145 17	inox brušena	170	10	160	35
<b>390144</b>	72 2146 17	inox brušena	202	10	192	35
<b>390145</b>	72 2147 17	inox brušena	234	10	224	35
<b>390146</b>	72 2149 17	inox brušena	298	10	288	35
<b>390147</b>	72 2150 17	inox brušena	330	10	320	35
<b>390148</b>	72 1257 17	inox brušena	426	10	416	35
<b>390149</b>	72 2152 17	inox brušena	458	10	448	35
<b>390150</b>	72 1261 17	inox brušena	522	10	512	35
<b>390151</b>	72 1262 17	inox brušena	554	10	544	35
<b>390152</b>	72 1264 17	inox brušena	650	10	640	35
<b>390153</b>	72 1266 17	inox brušena	746	10	736	35
<b>390154</b>	72 1268 17	inox brušena	842	10	832	35



## POHIŠTVENI ROČAJ ALUMINIJ

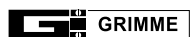

Šifra	Naziv	Obdelava	Dolžina mm	Globina mm	Razmik mm	Višina mm
390750	AL 2501 0160	izgled mat inoxa	290	12	160	27
390751	AL 2506 0160	črna mat	290	12	160	27



## POHIŠTVENI ROČAJ ALUMINIJ

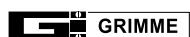

Šifra	Naziv	Obdelava	Dolžina mm	Globina mm	Razmik mm	Višina mm
390752	AL 2601 0192	izgled mat inoxa	290	18	192	24
390753	AL 2606 0192	črna mat	290	18	192	24



## POHIŠTVENI ROČAJ ALUMINIJ

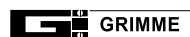

Šifra	Naziv	Obdelava	Dolžina mm	Globina mm	Razmik mm	Višina mm
390754	AL 2701 0192	izgled mat inoxa	290	22	192	23
390755	AL 2706 0192	črna mat	290	22	192	23



## POHIŠTVENI ROČAJ ALUMINIJ

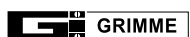

Šifra	Naziv	Obdelava	Dolžina mm	Globina mm	Razmik mm	Višina mm
390756	AL 2806 01	izgled mat inoxa	290	22	192	25
390757	AL 2806 0192	črna mat	290	22	192	25





## POHIŠTVENI ROČAJ ALUMINIJ



Šifra	Naziv	Obdelava	Dolžina mm	Globina mm	Razmik mm	Višina mm
390758	AL 2901 0192	izgled mat inoxa	290	21	160	22
390759	AL 2906 0192	črna mat	290	21	160	22



## POHIŠTVENI ROČAJ ALUMINIJ

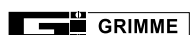

Šifra	Naziv	Obdelava	Dolžina mm	Globina mm	Razmik mm	Višina mm
391147	AL 1426 0128	črna sijaj	190	16	128	16

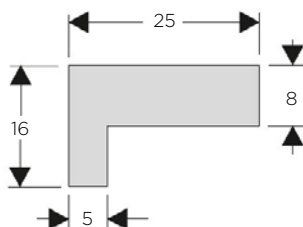

## POHIŠTVENI ROČAJ ALUMINIJ



Šifra	Naziv	Obdelava	Dolžina mm	Globina mm	Razmik mm	Višina mm
391198	AL 4626 0128	črna mat eloksirana	148	30	128	20
391199	AL 4626 0160	črna mat eloksirana	180	30	160	20
391200	AL 4626 0192	črna mat eloksirana	212	30	192	20
391201	AL 4626 0320	črna mat eloksirana	340	30	320	20



## POHIŠTVENI ROČAJ ALUMINIJ

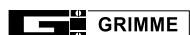

Šifra	Naziv	Obdelava	Dolžina mm	Globina mm	Razmik mm	Višina mm
391194	AL 4623 0128	bronasto zlata mat brušena	148	30	128	20
391195	AL 4623 0160	bronasto zlata mat brušena	180	30	160	20
391196	AL 4623 0192	bronasto zlata mat brušena	212	30	192	20
391197	AL 4623 0320	bronasto zlata mat brušena	340	30	320	20



# ENOVIAČNI POHIŠTVENI ROČAJI



Pri izbiri enovijačnih pohoštvenih ročajev, bodite pozorni na velikost in višino. Višino ročaja preverite še posebej, če je prostor med pohoštvom omejen. Izbirate lahko med različnimi kakovostnimi materiali kot so nerjaveče jeklo, aluminij ali zamak. Pomembno je tudi, da so ročaji enostavni za čiščenje in vzdrževanje. Poleg funkcionalnih potreb pa naj ne bo zanemarljiva tudi estetika. Pri izbiri ročajev upoštevajte stil vašega pohoštva in celotne notranje opreme. Površinska obdelava ročajev naj bo usklajena z ostalimi kovinskimi elementi v prostoru. Za harmoničen in usklajen videz priporočamo enoten slog ročajev v celotnem prostoru.

## POHIŠTVENI ROČAJ INOX

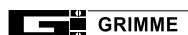

Šifra	Naziv	Obdelava	Premer (Ø) mm	Višina mm
390176	72 0523 17	inox satinirana	12	20
390177	72 0522 17	inox satinirana	15	22
390178	72 0521 17	inox satinirana	18	25
390179	72 0520 17	inox satinirana	21	25

## POHIŠTVENI ROČAJ INOX

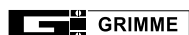

Šifra	Naziv	Obdelava	Premer (Ø) mm	Višina mm
390180	72 1575 17	inox satinirana	20	25
390181	72 1576 17	inox satinirana	24	30

## POHIŠTVENI ROČAJ INOX

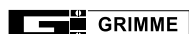

Šifra	Naziv	Obdelava	Premer (Ø) mm	Višina mm
390184	72 2111 17	inox satinirana	25	26
390183	72 2110 17	inox satinirana	20	22

## POHIŠTVENI ROČAJ ALUMINIJ



Šifra	Naziv	Obdelava	Premer (Ø) mm	Višina mm
390270	72 0522 47	barva aluminija	15	22
390271	72 0521 47	barva aluminija	18	25
390576	72 0521 46.16	črna	18	27
391164	72 0520 46.16	črna	21	27

## POHIŠTVENI ROČAJ ZAMAK

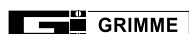

Šifra	Naziv	Barva	Premer (Ø) mm	Višina mm
391179	08 9930 16	črna	28	28



## POHIŠTVENI ROČAJ ALUMINIJ



Šifra	Naziv	Obdelava	Premer (Ø) mm	Višina mm
390272	72 1575 47	barva aluminija	20	25
390273	72 1576 47	barva aluminija	24	29

## POHIŠTVENI ROČAJ ALUMINIJ



Šifra	Naziv	Obdelava	Premer (Ø) mm	Višina mm
390275	72 2110 47	barva aluminija	20	22
390276	72 2111 47	barva aluminija	25	27
390277	72 2112 47	barva aluminija	30	32

## POHIŠTVENI ROČAJ ZAMAK



Šifra	Naziv	Obdelava	Dolžina mm	Širina mm	Višina mm
390545	73 7048 22	stari kositer	28	28	27

## POHIŠTVENI ROČAJ ALUMINIJ



Šifra	Naziv	Obdelava	Premer (Ø) mm	Višina mm
391164	72 0520 46.16	črna	21	27

## POHIŠTVENI ROČAJ ALUMINIJ



Šifra	Naziv	Obdelava	Premer (Ø) mm	Višina mm
391188	72 2755 46.16	črna mat eloksirana	35	25
391189	72 2755 46.24	zlata mat eloksirana	35	25

## POHIŠTVENI ROČAJ ZAMAK



Šifra	Naziv	Obdelava	Premer (Ø) mm	Višina mm
391162	72 2784 45	črna	28	31

# UTOPNI POHIŠTVENI ROČAJI



Utopni pohoštvni ročaji so elegantna in funkcionalna izbira. Zasnovani so tako, da se prilegajo površini pohoštva, kar ustvarja gladek in minimalističen videz. Ti ročaji so tudi izjemno praktični, saj preprečujejo zatikanje oblačil. Zaradi svoje vgradne zasnove, se velikokrat uporabljajo tudi v prostorih, kjer je veliko gibanja, saj zmanjšujejo tveganje za udarce in poškodbe. Utopni ročaji so na voljo v različnih oblikah, vključno z okroglimi, kvadratnimi, pravokotnimi. Izdelani so iz različnih materialov, kot so nerjaveče jeklo, aluminij, zamak, plastika. Oblikovani so za udoben prijem in enostavno odpiranje. Pri izbiri utopnih pohoštvenih ročajev bodite pozorni na globino ročaja, ki mora biti usklajena z debelino pohoštva.

## UTOPNI ROČAJ MEDENINA



Šifra	Naziv	Obdelava	Premer (ø) mm	Luknja (ø) mm	Globina mm
086050	Ročaj utopni fi25 mm	krom satinirana	29	25	21,5



## UTOPNI ROČAJ ZAMAK

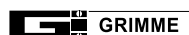

Šifra	Naziv	Obdelava	Premer (ø) mm	Luknja (ø) mm	Globina mm
390500	72 1181 29	krom	40	35	10
390501	72 1181 30	mat krom	40	35	10

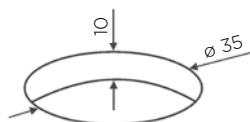

## UTOPNI ROČAJ INOX

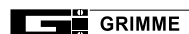

Šifra	Naziv	Obdelava	Premer (ø) mm	Luknja (ø) mm	Globina mm
390504	72 1192 19	inox brušena	40	35	14
390503	72 1194 19	inox brušena	50	40	14
390502	72 1190 19	inox brušena	70	60	14

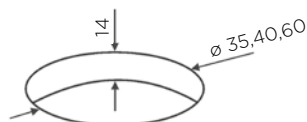

## UTOPNI ROČAJ ZAMAK



Šifra	Naziv	Obdelava	Dolžina mm	Višina mm	Razmik mm	Globina mm
390505	08 8376 19	izgled inoxa	204	60	192	15

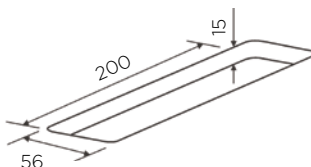

## UTOPNI ROČAJ INOX



Šifra	Naziv	Obdelava	Dolžina mm	Višina mm	Globina mm
390509	08 8055 17	inox brušena	180	60	15

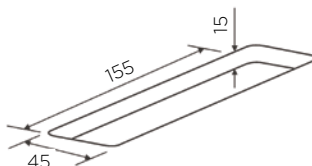



## UTOPNI ROČAJ ZAMAK

**GRIMME**



Šifra	Naziv	Obdelava	Dolžina mm	Višina mm	Globina mm
390510	08 9543 31	mat krom lakirana	108	42	14

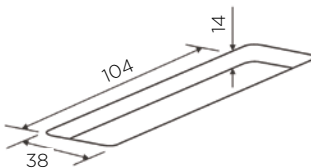

## UTOPNI ROČAJ ZAMAK

**GRIMME**



Šifra	Naziv	Obdelava	Dolžina mm	Višina mm	Globina mm
390516	72 1199 16	črna mat	119	40	17
390517	72 1199 19	izgled inoxa	119	40	17
390518	72 1199 30	mat krom	119	40	17

**LASTNOSTI:**  
- globina rezkanja: 15 mm

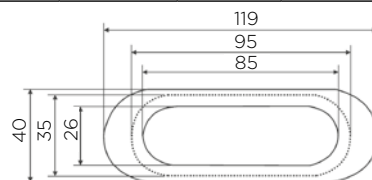

## UTOPNI ROČAJ PVC

**poliplast**



Šifra	Naziv	Obdelava	Dolžina mm	Višina mm	Globina mm
126191	124 x 40	črna	130	46	15

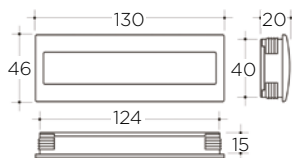

## UTOPNI ROČAJ PVC

**poliplast**



Šifra	Naziv	Obdelava	Dolžina mm	Višina mm	Globina mm
126194	069 75*26mm	RAL9006	80	31	15

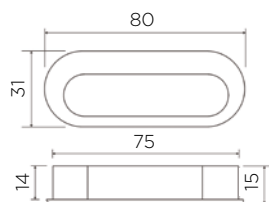

## UTOPNI ROČAJ PVC

**poliplast**

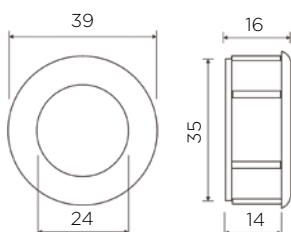

Šifra	Naziv	Obdelava	Premer (ø) mm	Globina mm
126193	053 fi 35 mm	RAL9006	35	16
126192	053 fi 35 mm	črna	39	16





## UTOPNI ROČAJ PVC

 poliplast

Šifra	Naziv	Obdelava	Premer (Ø) mm	Globina mm
126227	065 fi 50 mm	RAL9006	60	13

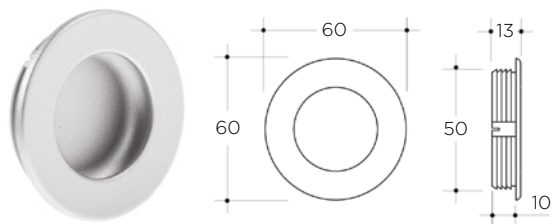

## UTOPNI ROČAJ PVC

 poliplast

Šifra	Naziv	Obdelava	Dolžina mm	Višina mm	Globina mm
126225	344 fi35mm	RAL9006	44	44	17

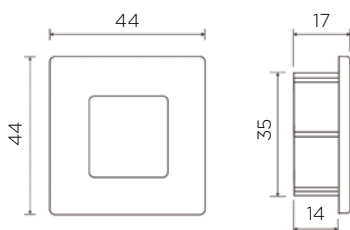

## UTOPNI ROČAJ PVC

 poliplast

Šifra	Naziv	Obdelava	Dolžina mm	Višina mm	Globina mm
126226	059 fi50mm	RAL9006	66	55	18

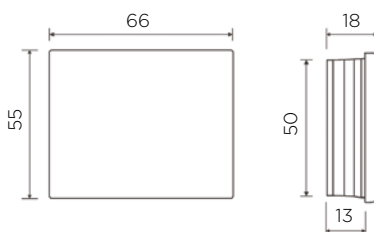

 GRIMME

Ti ročaji so tudi izjemno praktični, saj preprečujejo zatikanje oblačil. Zaradi svoje vgradne zasnove, se velikokrat uporabljajo tudi v prostorih, kjer je veliko gibanja, saj zmanjšujejo tveganje za udarce in poškodbe.



### ARTIKLI NA SLIKI:

390516: mat črn

390518: mat krom

# BREZVIJAČNI POHIŠTVENI ROČAJI

Brezvijačni pohištveni ročaji so sodobna rešitev za tiste, ki iščejo minimalističen videz, brez vidnih pritrdilnih elementov. Ti ročaji se še posebej podajo modernejšemu interiorju. So enostavni za namestitev in izjemno funkcionalni. Običajno se pritrdijo z lepilom ali posebnimi montažnimi sistemi. Kljub odsotnosti vijakov so ti ročaji trdno pritrjeni in zagotavljajo izjemno varno uporabo. Velikost izberite glede na velikost vašega pohištva. Za udobno uporabo in estetski videz pa bodite pozorni tudi na globino ročajev.

## POHIŠTVENI ROČAJ ALUMINIJ

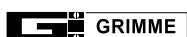

### LASTNOSTI:

- brez lukenj za vijake  
(sistem smrekice za montažo v izrez)

Šifra	Naziv	Obdelava	Dolžina mm	Globina mm	Višina mm
390385	AL 0802 0146	izgled mat inoxa	146	38	13
390386	AL 0802 0246	izgled mat inoxa	246	38	13
390387	AL 0802 0296	izgled mat inoxa	296	38	13
390388	AL 0802 0346	izgled mat inoxa	346	38	13
390389	AL 0802 0396	izgled mat inoxa	396	38	13
390390	AL 0802 0446	izgled mat inoxa	446	38	13
390391	AL 0802 0496	izgled mat inoxa	496	38	13
390392	AL 0802 0596	izgled mat inoxa	596	38	13

## POHIŠTVENI ROČAJ ALUMINIJ



### LASTNOSTI:

- brez lukenj za vijake  
(sistem smrekice za montažo v izrez)

Šifra	Naziv	Obdelava	Dolžina mm	Globina mm	Višina mm
391126	AL 0806 0246	črna eloksirana brušena	246	38	13
391127	AL 0806 0296	črna eloksirana brušena	296	38	13
391128	AL 0806 0346	črna eloksirana brušena	346	38	13
391129	AL 0806 0396	črna eloksirana brušena	396	38	13
391130	AL 0806 0446	črna eloksirana brušena	446	38	13
391131	AL 0806 0496	črna eloksirana brušena	496	38	13
391133	AL 0806 0596	črna eloksirana brušena	596	38	13



# DOLGI ALUMINIJASTI ROČAJI



Utopni pohišten ročaj ponujajo diskretno rešitev za odpiranje omar, predalov in drugih kosov pohištva. So idealna rešitev za tiste, ki iščejo sodobno, trpežno in estetsko rešitev. Zasnova teh ročajev je enostavna, njihova prednost pa je, da se odlično podajo k zelo različnim stilom notranje opreme. Aluminij je lahek, vendar močan material, ki zagotavlja dolgo življenjsko dobo in odpornost proti koroziji. Na voljo so v različnih oblikah in z različnimi površinskimi obdelavami, ki zagotavljajo dodatno zaščito ter vizualno privlačnost. Pri nakupu dolgih aluminijastih ročajih, bodite pozorni na dolžino, razdaljo med vijaki ter globino ročaja, da bo ročaj omogočal kar se da udobno uporabo.

## POHIŠTVENI ROČAJ ALUMINIJ

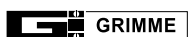

Šifra	Naziv	Obdelava	Dolžina mm	Višina mm	Globina mm
390383	AL 1101 3000	barva aluminija	3000	35	20

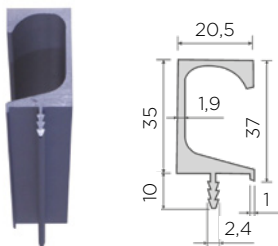

## POHIŠTVENI ROČAJ ALUMINIJ

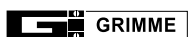

Šifra	Naziv	Obdelava	Dolžina mm	Višina mm	Globina mm
390393	AL 1201 3000	barva aluminija	3000	32	18
390399	AL 1210 3000	bela	3000	32	18
390394	AL 1206 3000	črna	3000	32	18

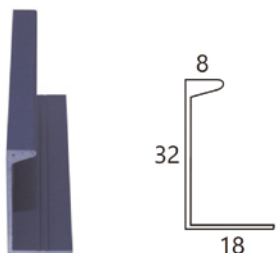

## POHIŠTVENI ROČAJ ALUMINIJ

Šifra	Naziv	Obdelava	Dolžina mm	Višina mm	Globina mm
092249	825 P.ročaj barva aluminija L=3000	barva aluminija	3000	35	20

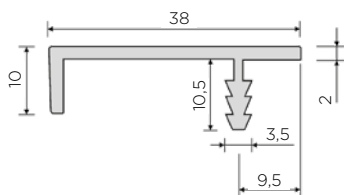



# ALUMINIJASTI PROFILI

Aluminij je zaradi svojih izjemnih lastnosti nepogrešljiv material v sodobnem pohištvu. Ponuja lahkost, trpežnost, odpornost na korozijo in estetsko privlačnost, ki zadovoljuje najvišje standarde tako pri oblikovanju kot pri funkcionalnosti pohištva. V našem katalogu boste našli aluminijaste profile, ki so skrbno zasnovani za različne pohištvene rešitve. Ne glede na to, ali potrebujete profile za kuhinjske elemente, omare, predelne stene ali druga pohištvena dela, naši izdelki zagotavljajo prilagodljivost in enostavnost uporabe. Vsak profil je natančno izdelan za optimalno prileganje, kar olajša montažo in prispeva k estetiki končnega izdelka. Naš strokovni tim vam je vedno na voljo za dodatna vprašanja in prilagojene rešitve, ki bodo izpolnile vaše specifične potrebe.

## GOLA "CLAP 'N' FIT" PROFILI

### PROFILI GOLA "CLAP 'N' FIT" G38

#### PULT/VERTIKALNI KONČNI 80/G38.AL



Šifra	Naziv
092301	"Gola Clap 38" Univerzalni enojni ALU, L=4,2m
092302	"Gola Clap 38" Univerzalni enojni BEL, L=4,2m
092303	"Gola Clap 38" Univerzalni enojni ČRN, L=4,2m
165338	"Gola Clap 38" Univerzalni enojni ZLAT, L=4,2m

#### LASTNOSTI:

- HORIZONTALNA MONTAŽA  
pod delovno ploščo
- VERTIKALNA MONTAŽA  
na koncu omare - vertikalni končni

- v primeru uporabe profila ne potrebujemo ročajev, saj vrata odpremo tako, da primemo za rob ličnice

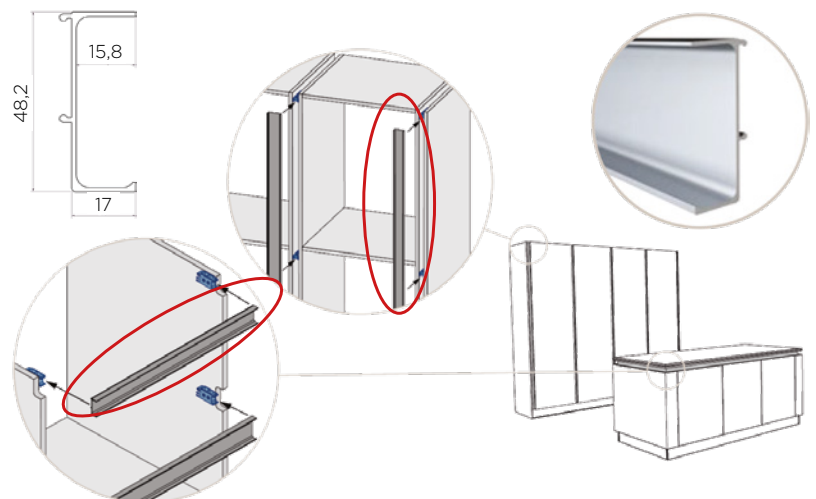

### PROFILI GOLA "CLAP 'N' FIT" G39

#### PREDAL/VERTIKALNI VMESNI 80/G39.AL



Šifra	Naziv
092304	"Gola Clap 39" Univerzalni dvojni ALU
092305	"Gola Clap 39" Univerzalni dvojni BEL
092306	"Gola Clap 39" Univerzalni dvojni ČRN
165339	"Gola Clap 39" Univerzalni dvojni ZLAT

#### LASTNOSTI:

- HORIZONTALNA MONTAŽA  
med predali
- VERTIKALNA MONTAŽA  
med omaro - vertikalni vmesni

- v primeru uporabe profila ne potrebujemo ročajev, saj vrata odpremo tako, da primemo za rob ličnice

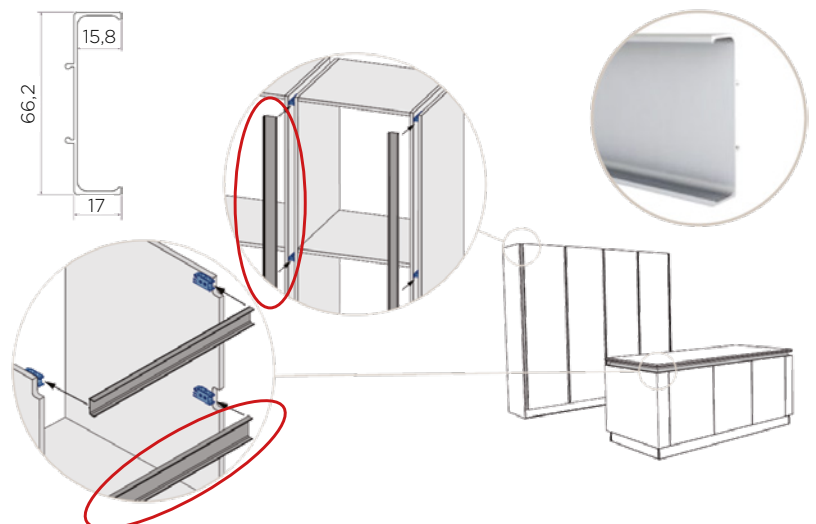

# GOLA "CLAP 'N' FIT" PROFILI

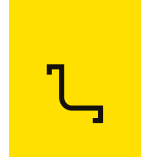

## PRITRDILEC GOLA CLAP' N' FIT + GOLA



Šifra	Naziv
092307	"Gola Clap + Gola" pritrdilec pakirano 10 kos

### LASTNOSTI:

- pritrdilec se uporablja za pritrditev ALU profila
- primeren za profil G38 in G39 + L in C profil
- za vertikalno in horizontalno montažo

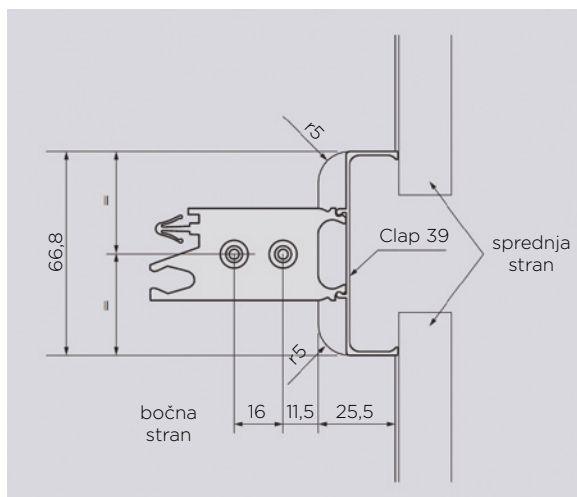
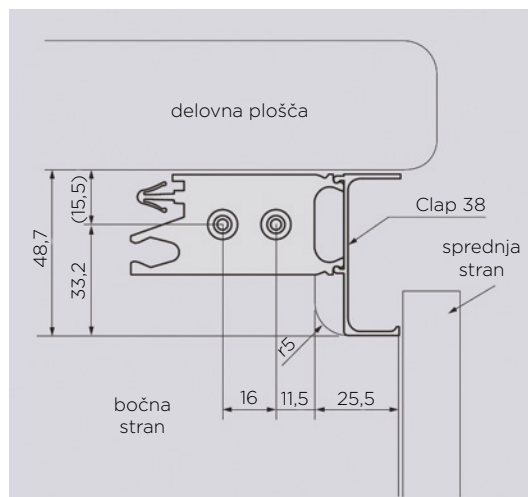
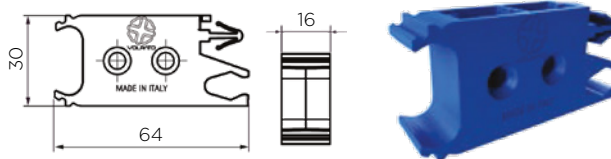

## ZUNANJA KAPICA ZA ALU PROFIL G38

Šifra	Naziv
092308	"Gola Clap" Kapica zunanja za G38 ALU
092309	"Gola Clap" Kapica zunanja za G38 BELA
092310	"Gola Clap" Kapica zunanja za G38 ČRNA
165342	"Gola Clap" Kapica zunanja za G38 ZLATA

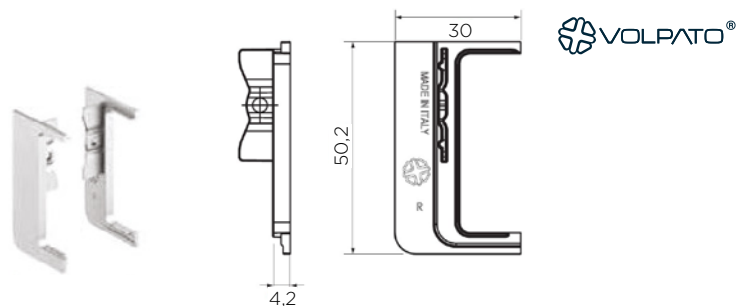

## ZUNANJA KAPICA ZA ALU PROFIL G39

Šifra	Naziv
092314	"Gola Clap" Kapica zunanja za G39 ALU
092315	"Gola Clap" Kapica zunanja za G39 BELA
092316	"Gola Clap" Kapica zunanja za G39 ČRNA
165344	"Gola Clap" Kapica zunanja za G39 ZLATA

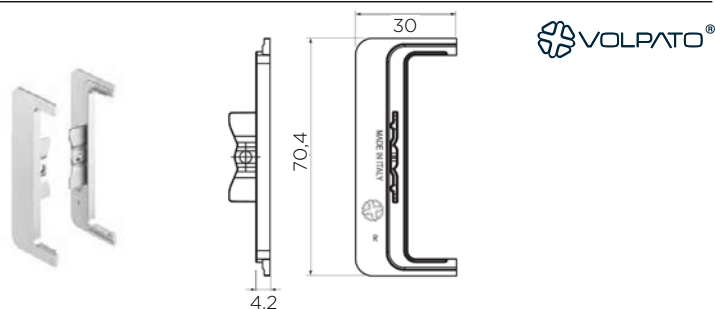

## NOTRANJA KAPICA ZA ALU PROFIL G38

Šifra	Naziv
092311	"Gola Clap" Kapica notranja za G38 ALU
092312	"Gola Clap" Kapica notranja za G38 BELA
092313	"Gola Clap" Kapica notranja za G38 ČRNA
165343	"Gola Clap" Kapica notranja za G38 ZLATA

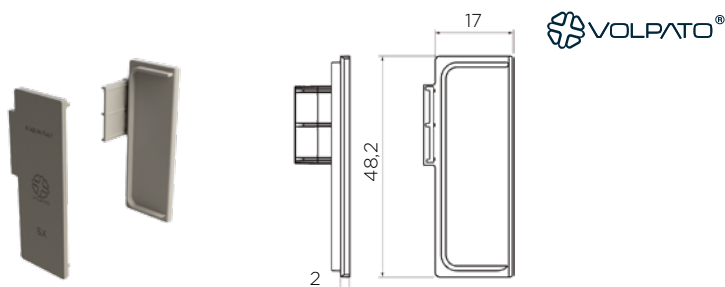



# GOLA "CLAP 'N' FIT" PROFILI

## NOTRANJA KAPICA ZA ALU PROFIL G39

Šifra	Naziv
092317	"Gola Clap" Kapica notranja za G39 ALU
092318	"Gola Clap" Kapica notranja za G39 BELA
092319	"Gola Clap" Kapica notranja za G39 ČRNA
165345	"Gola Clap" Kapica notranja za G39 ZLATA

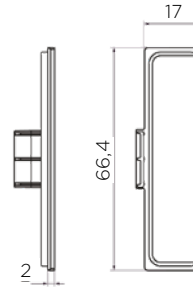

## ZUNANJI VOGALNIK 90° ZA ALU PROFIL G39

Šifra	Naziv
092335	"Gola Clap" vogalnik zunanji G39/90° ALU
092336	"Gola Clap" vogalnik zunanji G39/90° BEL
092337	"Gola Clap" vogalnik zunanji G39/90° ČRN
165341	"Gola Clap" vogalnik zunanji G39/90° ZLAT

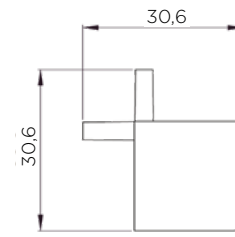

## ZUNANJI VOGALNIK 90° ZA ALU PROFIL G38

Šifra	Naziv
092323	"Gola Clap" Vogalnik zunanji G38/90° ALU
092324	"Gola Clap" Vogalnik zunanji G38/90° BEL
092325	"Gola Clap" Vogalnik zunanji G38/90° ČRN
165340	"Gola Clap" Vogalnik zunanji G38/90° ZLAT

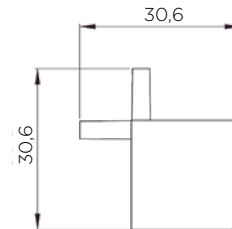

## NOTRANJI VOGALNIK 90° ZA ALU PROFIL G38

Šifra	Naziv
092329	"Gola Clap" Vogalnik notranji G38/90° ALU
092330	"Gola Clap" Vogalnik notranji G38/90° BEL
092331	"Gola Clap" Vogalnik notranji G38/90° ČRN
165347	"Gola Clap" Vogalnik notranji G38/90° ZLAT

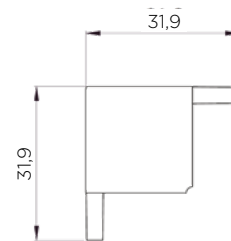

## NOTRANJI VOGALNIK 90° ZA ALU PROFIL G39

Šifra	Naziv
092341	"Gola Clap" Vogalnik notranji G39/90° ALU
092342	"Gola Clap" Vogalnik notranji G39/90° BEL
092343	"Gola Clap" Vogalnik notranji G39/90° ČRN
165348	"Gola Clap" Vogalnik notranji G39/90° ZLAT

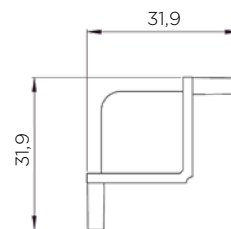

## ZUNANJI VOGALNIK 45° ZA ALU PROFIL G38

Šifra	Naziv
092326	"Gola Clap" vogalnik zunanji G38/45° ALU
092327	"Gola Clap" vogalnik zunanji G38/45° BEL
092328	"Gola Clap" vogalnik zunanji G38/45° ČRN
165349	"Gola Clap" vogalnik zunanji G38/45° ZLAT

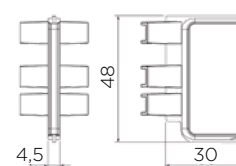

# GOLA "CLAP 'N' FIT" PROFILI

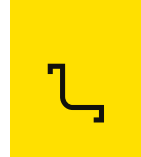

## ZUNANJI VOGALNIK 45° ZA ALU PROFIL G39



Šifra	Naziv
092338	"Gola Clap" vogalnik zunanji G39/45° ALU
092339	"Gola Clap" vogalnik zunanji G39/45° BEL
092340	"Gola Clap" vogalnik zunanji G39/45° ČRN
165350	"Gola Clap" vogalnik zunanji G39/45° ZLAT

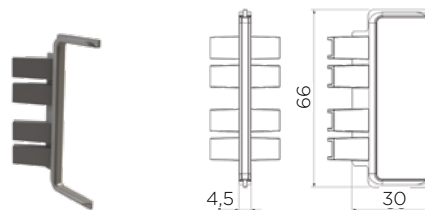

## NOTRANJI VOGALNIK 45° ZA ALU PROFIL G38, G39



Šifra	Naziv
092332	"Gola Clap" vogalnik notranji G38/45° ALU
092333	"Gola Clap" vogalnik notranji G38/45° BEL
092334	"Gola Clap" vogalnik notranji G38/45° ČRN
165351	"Gola Clap" vogalnik notranji G38/45° ZLAT



Šifra	Naziv
092344	"Gola Clap" vogalnik notranji G39/45° ALU
092345	"Gola Clap" vogalnik notranji G39/45° BEL
092346	"Gola Clap" vogalnik notranji G39/45° ČRN

## PROFIL ZA PEČICO GOLA CLAP' N' FIT

Šifra	Naziv
165357	"Gola Clap" profil za pečico L=602 mm ALU
165359	"Gola Clap" profil za pečico L=602 mm BEL
165358	"Gola Clap" profil za pečico L=602 mm ČRN

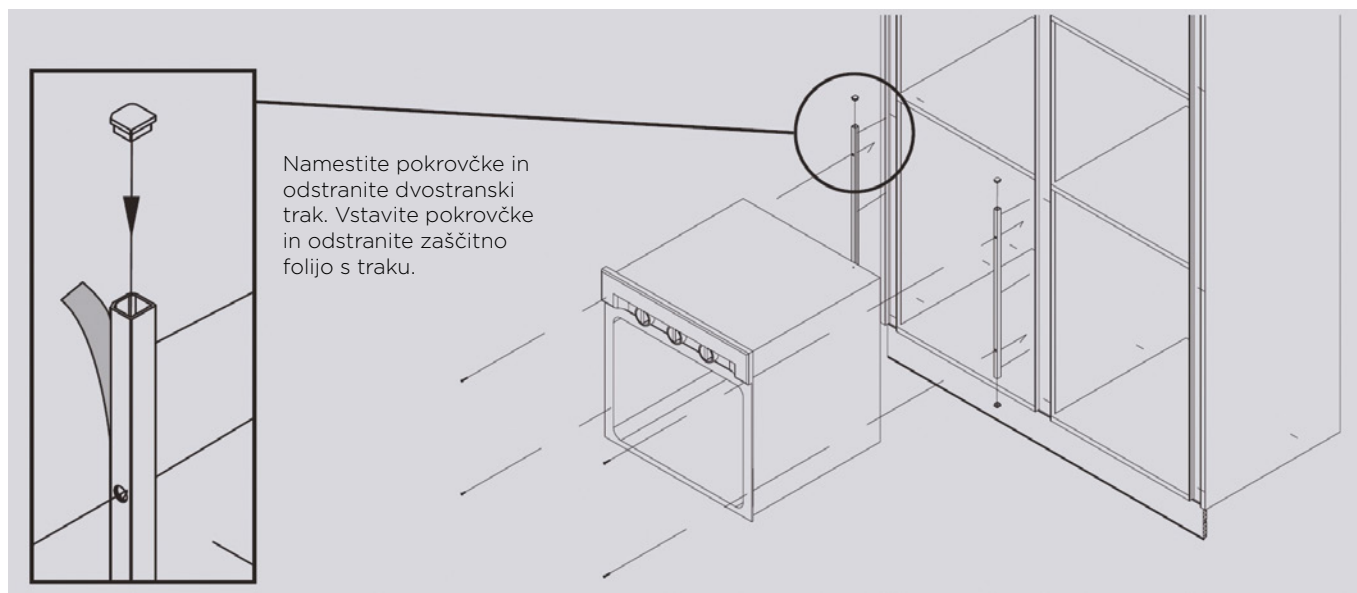
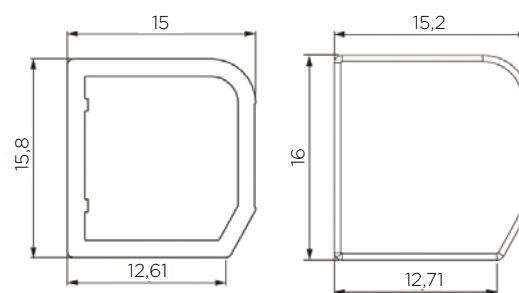



## HORIZONTALNI ALU PROFIL **GOLA L=4,2 m** **ZA MONTAŽO POD DELOVNO PLOŠČO**

Šifra	Naziv
092220	"GOLA" L profil horizontalni L=4,2m ALU
092260	"GOLA" L profil horizontalni L=4,2m BEL
092274	"GOLA" L profil horizontalni L=4,2m ČRN
165330	"GOLA" L profil horizontalni L=4,2m ZLAT
092224	"GOLA" L Kapice za zun.horizontalni ALU
092267	"GOLA" L Kapice za zun.horizontalni BELE
092294	"GOLA" L Kapice za zun.horizontalni ČRNE
165334	"GOLA" L Kapice za zun.horizontalni ZLATE
092232	"GOLA" L Kapice za not.horizontalni ALU
092268	"GOLA" L Kapice za not.horizontalni BELE
092295	"GOLA" L Kapice za not.horizontalni ČRNE
165335	"GOLA" L Kapice za not.horizontalni ZLATE
092226	"GOLA" Vogalnik "zunanji 90" ALU
092266	"GOLA" Vogalnik "zunanji 90" BEL
092293	"GOLA" Vogalnik "zunanji 90" ČRN
165333	"GOLA" Vogalnik "zunanji 90" ZLAT
092225	"GOLA" Vogalnik "notranji 90" ALU
092265	"GOLA" Vogalnik "notranji 90" BEL
092279	"GOLA" Vogalnik "notranji 90" ČRN
165356	"GOLA" Vogalnik "notranji 90" ZLAT

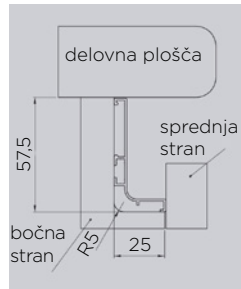

kapica L  
za zunanji profil



kapica L  
za notranji profil

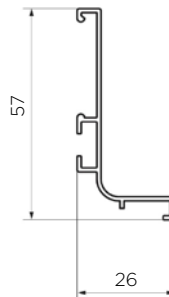

notranji vogalnik



zunanji vogalnik

### LASTNOSTI:

- v primeru uporabe profila ne potrebujemo ročajev, saj vrata odpremo tako, da primemo za rob ličnice

## HORIZONTALNI ALU PROFIL **GOLA L=4,2 m** **ZA MONTAŽO MED DVA PREDALA**

Šifra	Naziv
092221	"GOLA" C profil horizontalni L=4,2m ALU
092261	"GOLA" C profil horizontalni L=4,2m BEL
092278	"GOLA" C profil horizontalni L=4,2m ČRN
165331	"GOLA" C profil horizontalni L=4,2m ZLAT
092227	"GOLA" C kapice za zun. horizontalni ALU
092269	"GOLA" C kapice za zun. horizontalni BELE
092296	"GOLA" C kapice za zun. horizontalni ČRNE
165336	"GOLA" C kapice za zun. horizontalni ZLATE
092231	"GOLA" C kapice za not. horizontalni ALU
092270	"GOLA" C kapice za not. horizontalni BELE
092297	"GOLA" C kapice za not. horizontalni ČRNE
165337	"GOLA" C kapice za not. horizontalni ZLATE

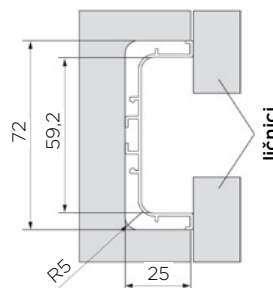

kapica C za zunanji profil



kapica C za notranji profil

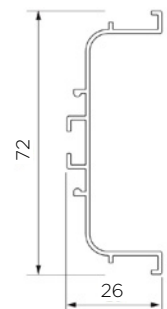



# GOLA PROFILI



## HORIZONTALNI ALU PROFIL **GOLA, L=4,2 m**

### ZA MONTAŽO NA DNO VISEČE OMARICE S TESNILOM

Šifra	Naziv
092219	"GOLA" profil zg.horizontalni L=4,2m ALU

#### LASTNOSTI:

- za montažo na dno viseče omare
- v primeru uporabe profila za vrata viseče omare ne potrebujemo pohištenih ročajev, saj vrata lahko odpremo tako, da primemo za spodnji del vrat viseče omare

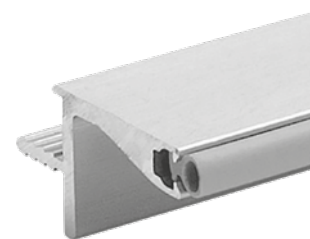
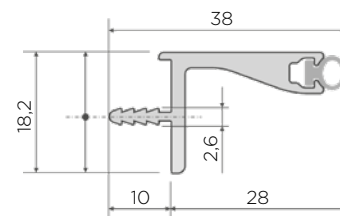
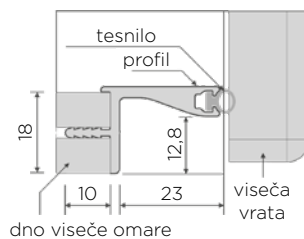

VOLPATO®

## HORIZONTALNI ALU PROFIL **GOLA, L=4,2 m**

### ZA MONTAŽO NA DNO VISEČE OMARICE BREZ TESNILA

Šifra	Naziv
092262	"GOLA" profil zg.horizontalni L=4,2m BEL
092277	"GOLA" profil zg.horizontalni L=4,2m ČRN

#### LASTNOSTI:

- za montažo na dno viseče omare
- v primeru uporabe profila za vrata viseče omare ne potrebujemo pohištenih ročajev, saj vrata lahko odpremo tako, da primemo za spodnji del vrat viseče omare

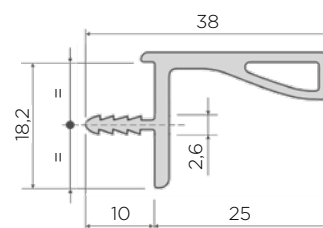
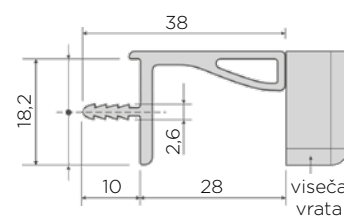

VOLPATO®

## VERTIKALNI ALU PROFIL **GOLA, L=4,7 m**

### ZA MONTAŽO MED POHIŠTVENA VRATA - ENOJNI

Šifra	Naziv
092223	"GOLA" profil enojni vertikalni L=4,7m ALU
092263	"GOLA" profil enojni vertikalni L=4,7m BEL
092276	"GOLA" profil enojni vertikalni L=4,7m ČRN
165352	"GOLA" profil enojni vertikalni L=4,7m ZLAT

#### LASTNOSTI:

- za montažo med pohištvena vrata
- v primeru uporabe profila za vrata ne potrebujemo pohištenih ročajev, saj vrata lahko odpremo tako, da primemo za rob vrat

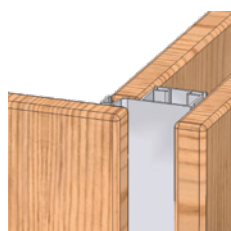

VOLPATO®

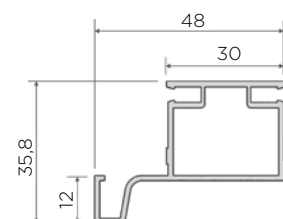
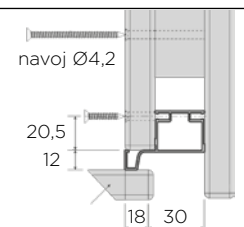

## VERTIKALNI ALU PROFIL **GOLA, L=4,7 m**

### ZA MONTAŽO MED POHIŠTVENA VRATA - DVOJNI

Šifra	Naziv
092222	"GOLA" Profil dvojni vertikalni L=4,7m ALU
092264	"GOLA" Profil dvojni vertikalni L=4,7m BEL
092275	"GOLA" Profil dvojni vertikalni L=4,7m ČRN
165332	"GOLA" Profil dvojni vertikalni L=4,7m ZLAT

#### LASTNOSTI:

- za montažo med pohištvena vrata
- v primeru uporabe profila za vrata ne potrebujemo pohištenih ročajev, saj vrata lahko odpremo tako, da primemo za rob vrat

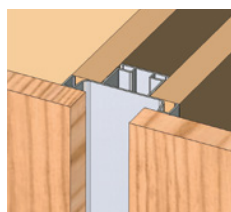

VOLPATO®

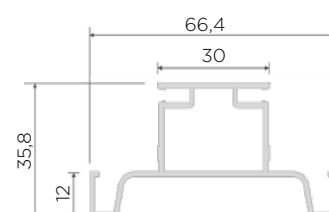
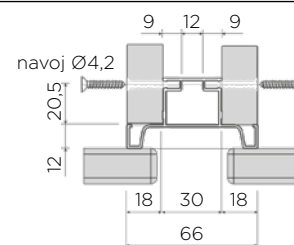



## VOGALNIK ZA PRITRDITEV PROFILA



Šifra	Naziv
092228	"GOLA" Vogalniki za pritrnitev ALU profila

### LASTNOSTI:

- vogalniki se uporabljajo za pritrnitev profila na stranico

### VSEBINA SETA:

- 2 pritrtilni plošči
- 4 pocinkani vijaki M4x4
- 4 vijaki za iverne plošče ø 3,5x12
- 4 podložke ø 12x1

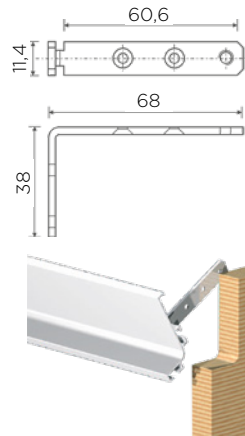

## PRITRDILEC GOLA "CLAP 'N' FIT + GOLA



Šifra	Naziv
092307	"Gola Clap + Gola" pritrtdilec pakirano 10 kos

### LASTNOSTI:

- pritrtdilec se uporablja za pritrditvev ALU profila
- primeren za profil G38 in G39 + L in C profil
- uporablja se za vertikalno in horizontalno montažo

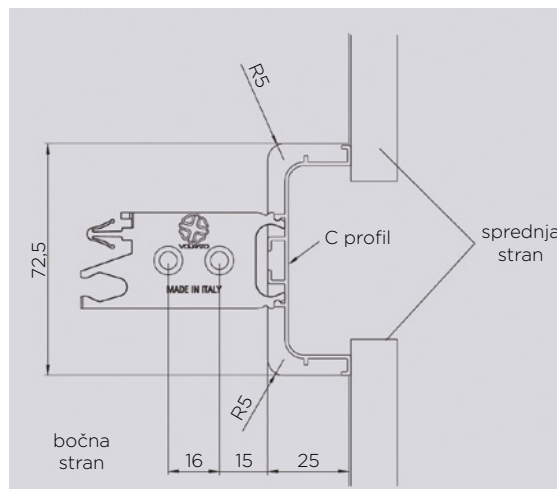
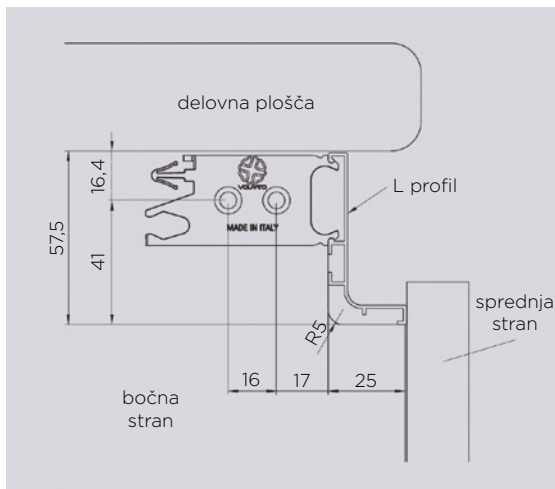
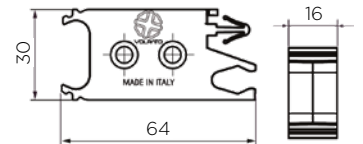

## PROFIL ZA PEČICO VOLPATO®

Šifra	Naziv
165353	"GOLA" Profil za pečico L=602mm ALU
165355	"GOLA" Profil za pečico L=602mm BEL
165354	"GOLA" Profil za pečico L=602mm ČRN

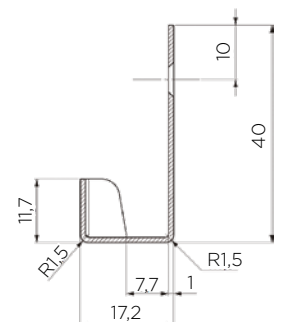
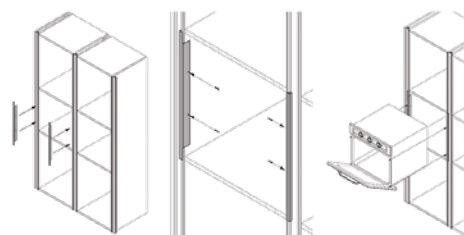

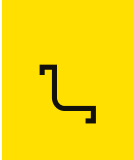

## ANDY JE MIKRO PROFIL,

zasnovan za konfiguracijo po meri, kar omogoča enostavno doseganje linearnih svetlobnih rešitev, prilagojenih "do milimetra" za montažo na podprofilih in podnožjih kuhinj. Kolekcija, ki jo sestavljajo univerzalni profil iz ekstrudiranega aluminija in montažni dodatki, omogoča ustvarjanje obrobnih konfiguracij za uporabo na kuhinjskih otokih in vogalih. Združuje ekstrudiran aluminijasti profil, ki je na voljo v anodizirani in mat črni izvedbi, ter lahko integrira svetlobni vir FLEXYLED SE H4-24, tako v enobarvni kot v dvobarvni različici D-Motion.



**Primer namestitve ANDY profila pod delovno površino kuhinjskega otoka s pritrdilnimi sponkami za gola profil.**



**Primer namestitve ANDY profila pod delovno površino kuhinjskega vogala s pritrdilnimi sponkami za gola profil.**

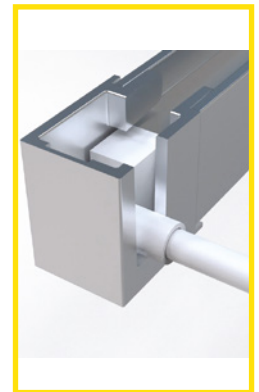

**Detajl zaključne kape in napajalnega kabla.**

## PROFIL ANDY

Šifra	Naziv	Obdelava	Dolžina mm
118177	ANDY - Profil za luč SE H4 L=3000mm ALU	barva aluminij	3000
118178	ANDY- Profil za luč SE H4 L=3000 mm ČRN	črna mat	3000



Profil ANDY je mogoče konfigurirati z dvema vrstama kotnih elementov: notranji pod kotom 90° za kuhinjske vogale in zunanji pod kotom 90° za kuhinjske otočke, ter z zaključnimi pokrovi za levo in desno stran, ki zakrivajo električni kabel.



## ZUNANJI KOTNIK ANDY

Šifra	Naziv	Obdelava
118179	ANDY-Kotnik zunanji ALU	barva aluminij
118180	ANDY-Kotnik zunanji ČRN	črna mat

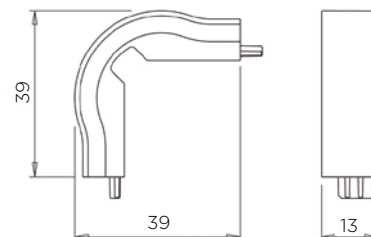

### LASTNOSTI:

- za namestitev na kuhinjskih otokih





## NOTRANJI KOTNIK **ANDY**

Šifra	Naziv	Obdelava
118181	ANDY- Kotnik notranji ALU	barva aluminij
118182	ANDY-Kotnik notranji ČRN	črna mat

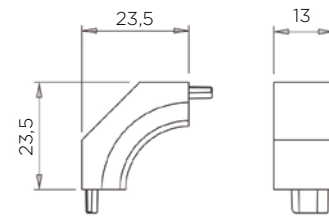

### LASTNOSTI:

- za namestitvev na vogalih kuhinjskih elementov



## ZAKLJUČNA KAPICA **ANDY**

Šifra	Naziv	Obdelava
118183	ANDY-Zaključna kapica ALU (leva + desna)	barva aluminij
118184	ANDY-Zaključna kapica ČRNA (leva + desna)	črna mat

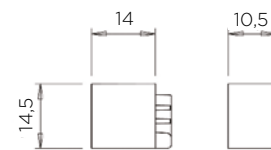

## SPONKE **ANDY**

Šifra	Naziv
118185	ANDY-SPONKE pak. 4kos

### LASTNOSTI:

- za pritrditev na Gola profil

-\*združljivost je potrebno preveriti

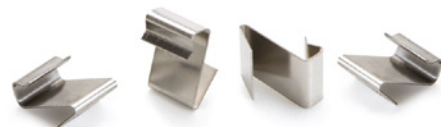

# GOLA PROFILI

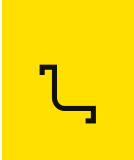

## FLEXYLED SE H4-24 D-M, 144 dvojnih LED/m, SILIKONSKA PREVLEKA

Šifra	Naziv	MOČ
118138	FLEXYLED LUČ - SE H4 19,2W 24V D-M 2,0m	19,2 W
118139	FLEXYLED LUČ - SE H4 24,0W 24V D-M 2,5m	24 W
118140	FLEXYLED LUČ - SE H4 28,8W 24V D-M 3,0m	28,8 W



Fleksibilen (gibljev) silikonski LED trak, izdelan z uporabnejšo tehnologijo za ekstrudiranje silikona. Trak je zasnovan za montažo v utor širine 4 mm in 8 mm globine in v profil Tynn.

### LASTNOSTI:

- napajanje: 24 Vdc
- moč: 9,6 W/m
- dolžina nap. kabla: 2x 200 cm (na vsakem koncu)
- barva svetlobe: D-Motion (naravna bela ali topla bela)
- dolžina LED traku: 200, 250, 300 cm
- število LE diod: 144 dvojnih LED/m
- konektor: Micro24
- izvor svetlobe: dvojni LED modul
- LED trak ovit v silikon: da
- rezanje LED traku: na vsakih 4,2 cm



### UPORABA IN NAMESTITEV:

- uporaba: za ambientalno osvetlitev
- namestitev: vgradnja v utor širine 4 mm in globine 8 mm ali v profil Tynn

### PRIMEREN TRANSFORMATOR:

- primerni so vsi 24 Vdc transformatorji v ponudbi. Pri izbiri bodite pozorni na moč, število priključkov in dodatne funkcije transformatorja

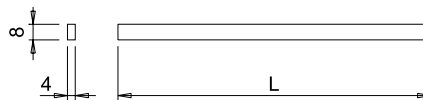

### PRIMEREN PROFIL:

- Tynn, stran 34

### FOTOMETRIČNI PODATKI:

- temp. svetlobe: 2700 - 4000 K
- svetlobni izkoristek: 85 lm/W
- CRI: Ra  $\geq$  90

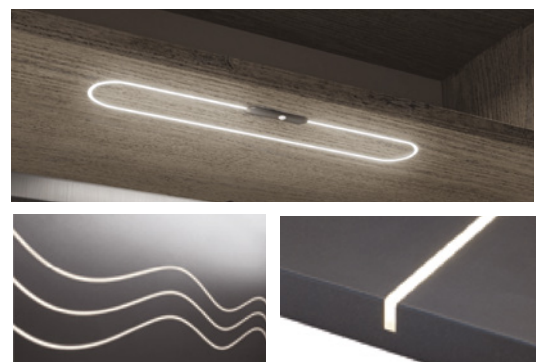
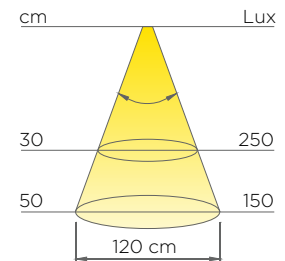



# ROČAJI ZA DRSNNA VRATA

## ALUMINIJASTI ROČAJ ZA 19mm

in TESNILNA KRTAČKA ZA ALU ROČAJ 931

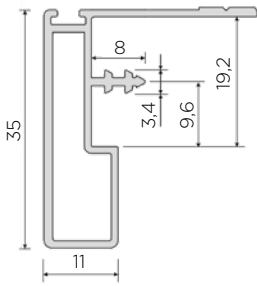

Šifra	Naziv	Dolžina/višina mm
092245	931 Alu. vratni ročaj za 19 mm	2780
092247	Krtačka tesnilna za ročaj 931	9

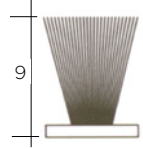

## ALUMINIJASTI SLEPI ROČAJ ZA 19mm

in TESNILNA KRTAČKA ZA SLEPI ALU ROČAJ 932

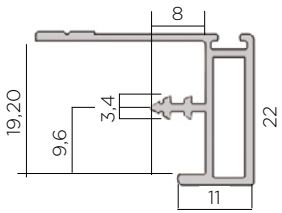

Šifra	Naziv	Dolžina/višina mm
092246	932 Alu. slepi ročaj za 19 mm	2780
092247	Krtačka tesnilna za ročaj 19 mm	9

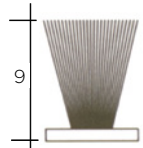

## ALUMINIJASTI ROČAJ ZA 25mm

in TESNILNA KRTAČKA ZA ALU ROČAJ 172

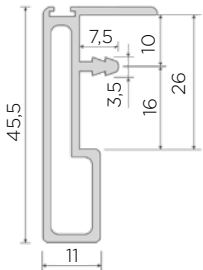

Šifra	Naziv	Dolžina/višina mm
092173	172 Alu. vratni ročaj za 25 mm	3000
092169	066 Krtačka tesnilna za ročaj 25 mm	9

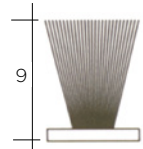

## ALUMINIJASTI SLEPI ROČAJ ZA 25mm

in TESNILNA KRTAČKA ZA SLEPI ALU ROČAJ 173

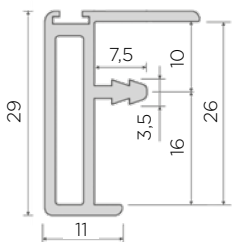

Šifra	Naziv	Dolžina/višina mm
092172	173 Alu. slepi ročaj za 25 mm	3000
092169	066 Krtačka tesnilna za ročaj 25 mm	9

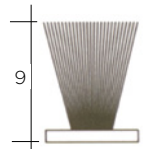

## BRIDGE 600 ROČAJ ZA IVERAL

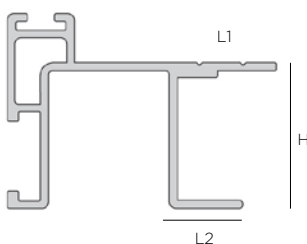

Šifra	Naziv	H mm	L1 mm	L2 mm	Obdelava
092418	Pohištenvi profil	20	15	10	barva aluminija
092478	Pohištenvi profil	20	15	10	bela RAL9016
092586	Pohištenvi profil	20	15	10	črna eloksirana

**Material:** aluminij

# ROČAJI ZA DRSNA VRATA



## BRIDGE 600 SLEPI ROČAJ ZA IVERAL

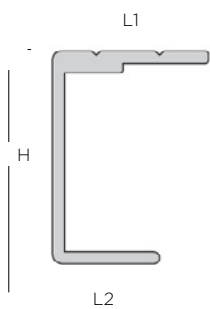

Šifra	Naziv	H mm	L1 mm	L2 mm	Obdelava
092419	Slepi ročaj za iveral	20	15	10	barva aluminija
092479	Slepi ročaj za iveral	20	15	10	bela RAL9016
092587	Slepi ročaj za iveral	20	15	10	črna eloksirana

**Material:** aluminij

## HORIZONTALNI T PROFIL ZA IVERAL

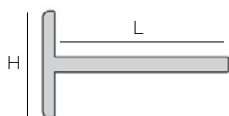

Šifra	Naziv	H mm	L mm	Obdelava
092420	Horizontalni T profil	10	19	barva aluminija
092477	Horizontalni T profil	10	19	bela RAL9016
092588	Horizontalni T profil	10	19	črna eloksirana

**Material:** aluminij

## BRIDGE 600 TESNILO ZA ROČAJ

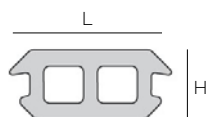

Šifra	Naziv	H mm	L mm	Barva
092458	Tesnilo za ročaj	5	13	črna
092422	Tesnilo za ročaj	5	13	siva

## BRIDGE 600 KRTAČKA ZA ROČAJ

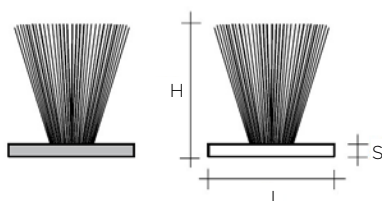

Šifra	Naziv	H mm	L mm	S mm	Barva
092459	Krtačka za ročaj	11	6,9	0,8	črna
092421	Krtačka za ročaj	11	6,9	0,8	siva

## SAMOLEPILNA KRTAČKA

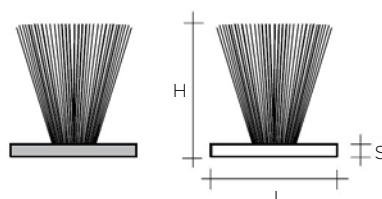

Šifra	Naziv	H mm	L mm	S mm	Barva
091101	Samolepilna krtačka	8	6,9	0,8	siva

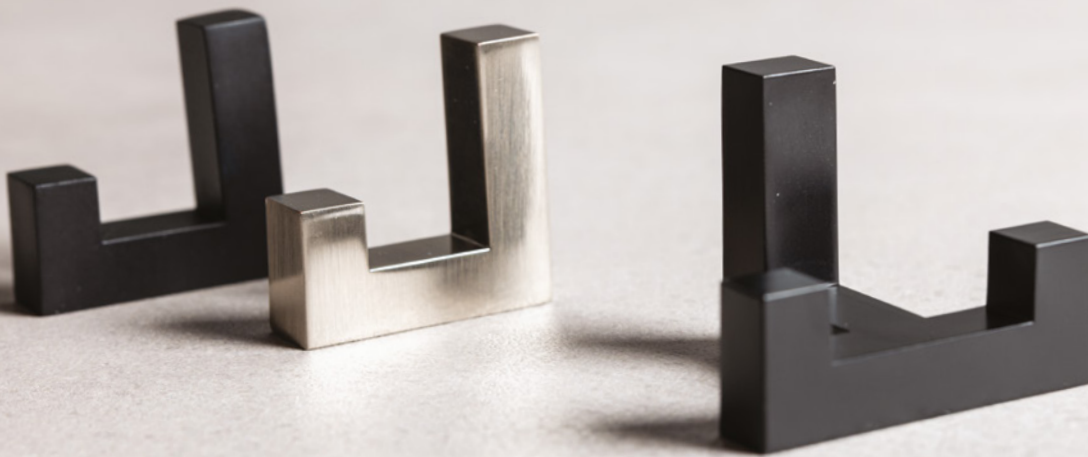

## POHIŠTVENI OBEŠALNIKI

Obešalniki niso le praktičen dodatek, ampak tudi ključen element vsakega doma, ki pomaga ohranjati red in organizacijo. Na voljo so v različnih stilih, materialih in velikostih, kar omogoča prilagoditev vsakemu prostoru in potrebam. Pri nakupu bodite pozorni na nosilnost, trdnost materialov in način montaže. Pravilna namestitvev je ključna za stabilnost in varno uporabo zato uporabite ustrezne pritrdilne elemente. Izberite obešalnik, ki bo funkcionalen, hkrati pa bo estetsko dopolnjeval vaš prostor.

### POHIŠTVENI OBEŠALNIK ALUMINIJ



Šifra	Naziv	Obdelava	Višina mm	Širina mm	Razmik mm
<b>390403</b>	75 0911 47	barva aluminija	80	55	20
<b>390402</b>	75 0910 47	barva aluminija	180	55	20



# POHIŠTVENI OBEŠALNIKI

## POHIŠTVENI OBEŠALNIK ZAMAK

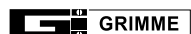

Šifra	Naziv	Obdelava	Višina mm	Širina mm	Razmik mm
390481	75 6211 29	krom	63	54	32
390482	75 6211 27	mat nikelj	63	54	32
390486	75 6210 27	krom	140	110	32
390485	75 6210 29	mat nikelj	140	110	32

## POHIŠTVENI OBEŠALNIK ZAMAK

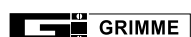

Šifra	Naziv	Obdelava	Višina mm	Širina mm	Razmik mm
390431	75 6151 29	krom	55	78	32
390432	75 6151 31	mat krom lakirana	55	78	32
390430	75 6151 27	mat nikelj	55	78	32
390433	75 6151 39	bela	55	78	32
390434	75 6151 45	črna	55	78	32
390425	75 6150 29	krom	160	78	32
390426	75 6150 31	mat krom lakirana	160	78	32
390424	75 6150 27	mat nikelj	160	78	32
390427	75 6150 39	bela	160	78	32

## POHIŠTVENI OBEŠALNIK ZAMAK

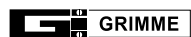

Šifra	Naziv	Obdelava	Višina mm	Širina mm	Razmik mm
390453	75 6271 29	krom	45	58	20
390454	75 6271 30	mat krom	45	58	20
390452	75 6271 27	mat nikelj	45	58	20
390449	75 6270 30	mat krom	127	125	20

## POHIŠTVENI OBEŠALNIK ZAMAK

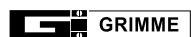

Šifra	Naziv	Obdelava	Višina mm	Širina mm	Razmik mm
390443	75 6261 29	krom	45	58	18
390444	75 6261 30	mat krom	45	58	18
390438	75 6260 29	krom	114	90	40
390439	75 6260 30	mat krom	114	90	40

## POHIŠTVENI OBEŠALNIK ZAMAK

GRIMME



Šifra	Naziv	Obdelava	Višina mm	Širina mm	Globina mm	Razmik mm
390556	75 6411 19	izgled inoxa	47	70	25	32
390557	75 6411 30	mat krom	47	70	25	32

Šifra	Naziv	Obdelava	Višina mm	Širina mm	Globina mm	Razmik mm
390554	75 6410 19	izgled inoxa	142	70	25	32
390555	75 6410 30	mat krom	142	70	25	32

## POHIŠTVENI OBEŠALNIK ZAMAK

GRIMME



Šifra	Naziv	Obdelava	Višina mm	Širina mm	Razmik mm
390468	75 0601 19	izgled inoxa	80	17	18
390469	75 0601 29	krom	80	17	18
390470	75 0601 30	mat krom	80	17	18

390465	75 0600 19	izgled inoxa	155	17	18
390466	75 0600 29	krom	155	17	18
390467	75 0600 30	mat krom	155	17	18

## POHIŠTVENI OBEŠALNIK ZAMAK

GRIMME



Šifra	Naziv	Obdelava	Višina mm	Širina mm	Globina mm	Razmik mm
390475	75 0551 29	krom	57	50	22	18
390476	75 0551 30.1	mat krom	57	50	22	18

390471	75 0550 19	izgled inoxa	141	50	59	18
390472	75 0550 29	krom	141	50	59	18
390473	75 0550 30	mat krom	141	50	59	18
390484	75 0550 23	pozlačena	141	50	59	18

## POHIŠTVENI OBEŠALNIK JEKLO

GRIMME



Šifra	Naziv	Obdelava	Višina mm	Širina mm	Razmik mm
390461	75 0700 29	krom	225	53	24
390462	75 0700 30	mat krom	225	53	24

390463	75 0701 29	krom	150	53	22
390464	75 0701 30	mat krom	150	53	22

### POHIŠTVENI OBEŠALNIK INOX

**GRIMME**



Šifra	Naziv	Obdelava	Višina mm	Širina mm	Premer (ø) mm	Razmik mm
390413	75 9008 17	inox brušena	90	50	10	42
390412	75 9007 17	inox brušena	190	52	10	42

### POHIŠTVENI OBEŠALNIK ZAMAK

**GRIMME**



Šifra	Naziv	Obdelava	Višina mm	Širina mm	Razmik mm
390559	75 6161 36	bronirana antik	65	83	32
390558	75 6160 36	bronirana antik	170	83	32

### POHIŠTVENI OBEŠALNIK JEKLO

**STARMAN®**

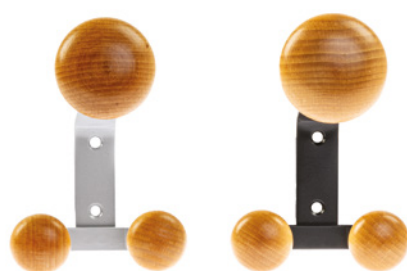

Šifra	Naziv	Obdelava	Višina mm	Širina mm	Razmik mm
095532	kljuka obešalna enojna K-160	hrast siva	120	84	33
095530	kljuka obešalna enojna K-160	hrast črna	120	84	33

### POHIŠTVENI OBEŠALNIK JEKLO

**SISO DENMARK**



Šifra	Naziv	Obdelava	Višina mm	Širina mm	Razmik mm
129124	X obešalnik "OCTA"	črna mat	47	53	16,5
129125	X obešalnik "OCTA"	izgled inoxa	47	53	16,5
129126	X obešalnik "OCTA"	bronirana	47	53	16,5

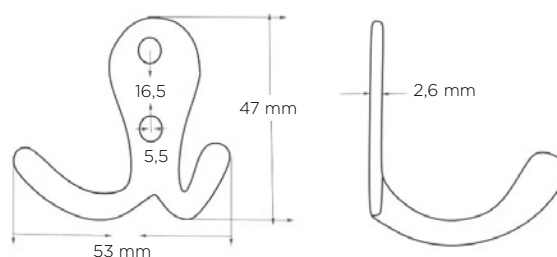

## POHIŠTVENI OBEŠALNIK ALUMINIJ

 GRIMME



Šifra	Naziv	Obdelava	Višina mm	Širina mm	Razmik mm
390401	75 0901 47	črna	72	16	20
391153	75 0901 16	črna	72	16	20
390400	75 0900 47	črna	175	16	20
391152	75 0900 16	črna	175	16	20

## POHIŠTVENI OBEŠALNIK INOX

 GRIMME



Šifra	Naziv	Obdelava	Višina mm	Širina mm	Razmik mm
390411	75 1051 17	inox brušena	60	20	20
391155	75 1051 16	črna	60	20	20
390410	75 1050 16	inox brušena	142	20	20
391154	75 1050 16	črna	142	20	20

## POHIŠTVENI OBEŠALNIK JEKLO

**STARMAN®**



Šifra	Naziv	Obdelava	Višina mm	Širina mm	Razmik mm
095580	kljuka obešalna enojna K-50	bela	50	20	18
095581	kljuka obešalna enojna K-50	črna	50	20	18
095582	kljuka obešalna enojna K-50	siva	50	20	18
095583	kljuka obešalna dvojna K-100	bela	100	20	18
095584	kljuka obešalna dvojna K-100	črna	100	20	18
095585	kljuka obešalna dvojna K-100	siva	100	20	18
095538	kljuka obešalna dvojna K-140	bela	140	20	18
095539	kljuka obešalna dvojna K-140	črna	140	20	18
095540	kljuka obešalna dvojna K-140	siva	140	20	18



Z uporabo obešalnikov v predsobi poskrbite za udobje vaših gostov in bolj urejen videz.

**POHIŠTVENI OBEŠALNIK ZAMAK**

Šifra	Naziv	Obdelava	Višina mm	Širina mm	Globina mm	Razmik mm
<b>390552</b>	75 6325 19	izgled inoxa	58	110	40	12
<b>390553</b>	75 6325 30	mat krom	58	110	40	12

**POHIŠTVENI OBEŠALNIK ZAMAK**



Šifra	Naziv	Obdelava	Višina mm	Širina mm	Globina mm	Razmik mm
<b>390496</b>	75 6321 19	izgled inoxa	29	72	38	12
<b>390493</b>	75 6321 30	mat krom	29	72	38	12

**POHIŠTVENI OBEŠALNIK ZAMAK**

Šifra	Naziv	Obdelava	Višina mm	Širina mm	Globina mm	Razmik mm
<b>390494</b>	75 6431 19	izgled inoxa	40	12	40	15
<b>390497</b>	75 6431 16	črna lakirana	40	12	40	15

**POHIŠTVENI OBEŠALNIK ZAMAK**

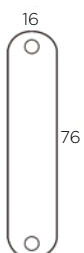
Šifra	Naziv	Obdelava	Višina mm	Širina mm	Globina mm	Razmik mm
<b>390495</b>	75 6432 19	izgled inoxa	40	52	40	15
<b>390498</b>	75 6432 16	črna	40	52	40	15

**POHIŠTVENI OBEŠALNIK ZAMAK**

Šifra	Naziv	Obdelava	Višina mm	Širina mm	Razmik mm
<b>390397</b>	75 7310 16	črna	80	20	66
<b>390492</b>	75 7310 31	mat krom lakirana	80	20	66

**LASTNOSTI:**

- max. obremenitev: 10 kg

## PREKLOPNI OBEŠALNIK **ZAMAK**

GRIMME



Šifra	Naziv	Obdelava	Višina mm	Širina mm	Razmik mm
390491	75 7300 31	mat krom lakirana	140	16	128
390398	75 7300 16	črna	140	16	128

### LASTNOSTI:

- max. obremenitev: 10 kg

## PREKLOPNI OBEŠALNIK **CROC**

SISO

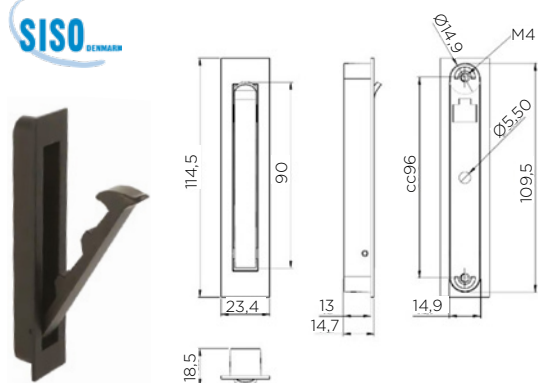

Šifra	Naziv	Obdelava	Višina mm	Širina mm	Globina mm
129127	X-obešalnik "Croc"	črna mat	114,5	23,4	13
129128	X-obešalnik "Croc"	izgled inoxa	114,5	23,4	13

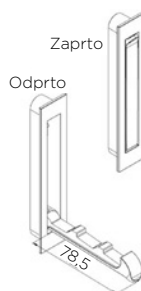

## PREKLOPNI OBEŠALNIK **HIPPO**

SISO

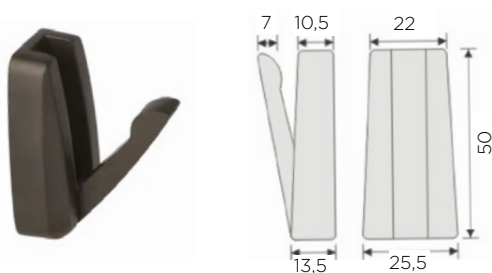

Šifra	Naziv	Obdelava	Višina mm	Širina mm	Razmik mm
129129	X-obešalnik "Hippo"	črna mat	50	22/25,5	15
129130	X-obešalnik "Hippo"	izgled inoxa	50	22/25,5	15

## POHIŠTVENI OBEŠALNIK INOX

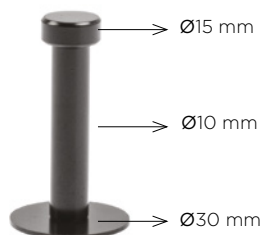
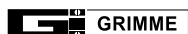

Šifra	Naziv	Obdelava	Višina mm	Premer (Ø) mm
391156	75 0430 16	črna	32	30/10/15
391157	75 0431 16	črna	52	30/10/15
391158	75 0432 16	črna	72	30/10/15

## POHIŠTVENI OBEŠALNIK ZAMAK

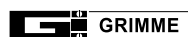

Šifra	Naziv	Obdelava	Dolžina mm	Višina mm	Globina mm	Razmik mm
391175	75 6480 16	črna	85	63	63	32

## POHIŠTVENI OBEŠALNIK ZAMAK

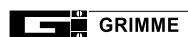

Šifra	Naziv	Obdelava	Širina mm	Višina mm	Globina mm	Razmik mm
391176	75 6481 16	črna	12	53	33	32

## POHIŠTVENI OBEŠALNIK ZAMAK



Šifra	Naziv	Obdelava	Širina mm	Višina mm	Globina mm	Razmik mm
391177	75 6482 16	črna	70	63	40	32

## POHIŠTVENI OBEŠALNIK ALUMINIJ

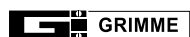

Šifra	Naziv	Obdelava	Višina mm	Premer (Ø) mm
390446	75 6475 46.11	srebrna	58	51
390451	75 6475 46	krom	58	51

## POHIŠTVENI OBEŠALNIK ALUMINIJ



Šifra	Naziv	Obdelava	Število obeš.	Dolžina mm	Višina mm	Razmik mm
390477	75 7202 47.47	barva aluminija	2	150	40	130
390478	75 7203 47.47	barva aluminija	3	220	40	90
390479	75 7204 47.47	barva aluminija	4	300	40	173

## POHIŠTVENI OBEŠALNIK INOX

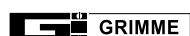

Šifra	Naziv	Obdelava	Število obeš.	Dolžina mm	Višina mm	Razmik mm
390560	75 7525 17	inox brušena	5	380	53	211

## POHIŠTVENI OBEŠALNIK INOX



Šifra	Naziv	Obdelava	Število obeš.	Dolžina mm	Višina mm	Razmik mm
390561	75 7514 17	inox brušena	4	300	38	158
390562	75 7515 17	inox brušena	5	380	38	246

## POHIŠTVENI OBEŠALNIK JEKLO



Šifra	Naziv	Obdelava	Število obeš.	Dolžina mm	Višina mm	Razmik mm
391214	75 7703 16	črna mat	3	290	45	115
391215	75 7704 16	črna mat	4	405	45	230
391216	75 7705 16	črna mat	5	405	45	230



# SAMOLEPILNI OBEŠALNIKI

## POHIŠTVENI OBEŠALNIK INOX

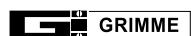

Šifra	Naziv	Obdelava	Število obeš.	Dolžina mm	Višina mm	Max. obrem. kg
<b>390563</b>	75 7601 17	inox brušena	1	50	50	6
<b>390567</b>	75 7601 29	krom	1	50	50	6
<b>390564</b>	75 7602 17	inox brušena	2	100	50	8
<b>390568</b>	75 7602 29	krom	2	100	50	8
<b>390565</b>	75 7603 17	inox brušena	3	150	50	10
<b>390569</b>	75 7603 29	krom	3	150	50	10
<b>390566</b>	75 7604 17	inox brušena	4	200	50	15
<b>390591</b>	75 7604 29	krom	4	200	50	15

## POHIŠTVENI OBEŠALNIK INOX

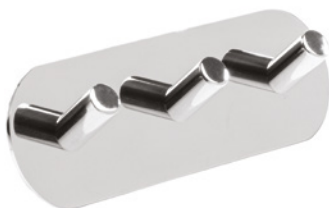
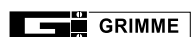

Šifra	Naziv	Obdelava	Število obeš.	Dolžina mm	Višina mm	Max. obrem. kg
<b>390592</b>	75 7611 17	inox brušena	1	50	50	6
<b>390596</b>	75 7611 29	krom	1	50	50	6
<b>390593</b>	75 7612 17	inox brušena	2	100	50	8
<b>390597</b>	75 7612 29	krom	2	100	50	8
<b>390594</b>	75 7613 17	inox brušena	3	150	50	10
<b>390598</b>	75 7613 29	krom	3	150	50	10
<b>390595</b>	75 7614 17	inox brušena	4	200	50	15
<b>390599</b>	75 7614 29	krom	4	200	50	15





## NOSILCI ZA TOALETNI PAPIR

### NOSILEC ZA TOALETNI PAPIR INOX

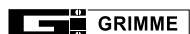

Šifra	Naziv	Obdelava	Širina mm	Višina mm	Globina mm
390720	75 7600 17	inox brušena	150	95	29
390719	75 7600 29	krom	150	95	29

### POHIŠTVENI OBEŠALNIK INOX

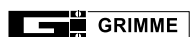

Šifra	Naziv	Obdelava	Širina mm	Višina mm	Globina mm
390723	75 7610 17	inox brušena	150	95	29
390519	75 7600 29	krom	150	95	29

Samolepilni obešalniki so odlična rešitev, če se želimo izogniti vrtanju in poškodbam sten. Še posebej priročni so za kopalnice, kjer si z njimi lahko omogočimo večje udobje in praktičnost brez uničevanja ploščic.



# ROČAJI ZA OGRAJE, ZAKLJUČNI ČEPI

## ROČAJ ZA OGRAJO LES

**STARMAN®**



Šifra	Naziv	Obdelava	Premer (Ø) mm	Dolžina mm
095352	fi 45 mm HRAST	surov	45	vse do 3100
095353	fi 45 mm BUKEV	surova	45	vse do 3100
095355	fi 45 mm JESEN	surov	45	vse do 3100
095351	fi 45 mm SMREKA	surova	45	vse dolžine
095354	fi 45 mm JAVOR	surov	45	vse dolžine
095373	fi 45 mm HRAST	surov	45	od 3100 naprej
095374	fi 45 mm BUKEV	surova	45	od 3100 naprej
095376	fi 45 mm JESEN	surova	45	od 3100 naprej

### LASTNOSTI:

- lesen ročaj, na voljo v različnih dolžinah

## ROČAJI LOK ZA OGRAJO LES

**STARMAN®**



Šifra	Naziv	Obdelava	Kot	Premer (Ø) mm
095340	fi 45 mm 30" BUKEV	blago parjena	30 °	45
095341	fi 45 mm 45" BUKEV	blago parjena	45 °	45
095342	fi 45 mm 90" BUKEV	blago parjena	90 °	45

### OPIS:

Ročaji so prirezani na določen kot, čelno obdelani za spajanje oziroma zaključevanje (izvrtine za moznični čep, posnet končni rob), pakirani v blister embalažo (priloženi so potrebni mozniki in lepilo za les), označeni z vsemi potrebnimi podatki za nemoteno manipulacijo in prodajo.

## ZAKLJUČNI ČEPI ZA ROČAJ

**STARMAN®**



Šifra	Naziv	Dolžina mm	Premer (Ø) mm	Pak. kos
095343	Čep zaključ. za ročaj fi 45 mm BUKEV P.	22,5	45	2
095344	Čep zaključ. za ročaj fi 45 mm MEDENINA	22,5	45	2
095345	Čep zaključ. za ročaj fi 45 mm KROM	22,5	45	2
095346	Čep zaključ. za ročaj fi 45 mm SIV	22,5	45	2
095347	Čep zaključ. za ročaj fi 45 mm BEL	22,5	45	2
095348	Čep zaključ. za ročaj fi 45 mm RJAV	22,5	45	2
095349	Čep zaključ. za ročaj fi 45 mm HRAST	22,5	45	2

### OPIS:

Zaključni čepi so obdelani za spajanje (izvrtina za množični čep, posnet rob), pakirani v blister embalažo (priloženi so potrebni mozniki in lesno lepilo) in označeni z vsemi potrebnimi podatki za nemoteno manipulacijo in prodajo.

## DRŽALO ZA OGRAJO KOVINA, INOX

### STARMAN®

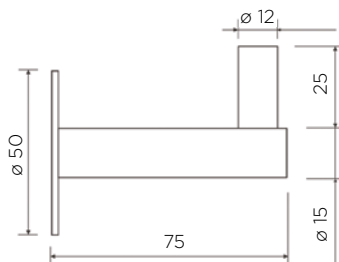

Šifra	Naziv	Obdelava	Premer mm	Dolžina mm	Višina mm
095501	Držalo za ograjo "L"	bela	50	70	40
095507	Držalo za ograjo "L"	siva	50	70	40
095509	Držalo za ograjo "L"	rjava	50	70	40
195384	Držalo za ograjo "L"	črna	50	70	40
195385	Držalo za ograjo "L"	antracit	50	70	40

095508	Držalo za ograjo "L"	inox	50	70	40
--------	----------------------	------	----	----	----

#### LASTNOSTI:

- priložen zidni vložek, vijak in ploščica za okrogle lesene ročaje
- možna izdelava držal za montažo na gips plošče/stene



## DRŽALO ZA OGRAJO KOVINA, INOX

### STARMAN®

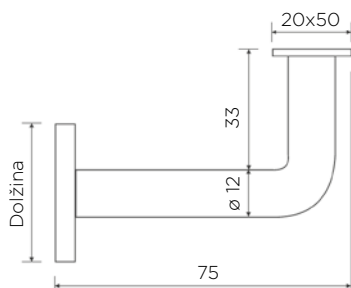

Šifra	Naziv	Obdelava	Premer mm	Dolžina mm	Višina mm
095498	Držalo za ograjo	bela	35	65	45
095499	Držalo za ograjo	siva	35	65	45
095500	Držalo za ograjo	rjava	35	65	45
095506	Držalo za ograjo	krom	35	65	45
095526	Držalo za ograjo	črna	35	65	45
195386	Držalo za ograjo	antracit	35	65	45

095525	Držalo za ograjo	inox	50	65	45
--------	------------------	------	----	----	----

#### LASTNOSTI:

- priložen zidni vložek, vijak in ploščica za okrogle lesene ročaje
- možna izdelava držal za montažo na gips plošče/stene

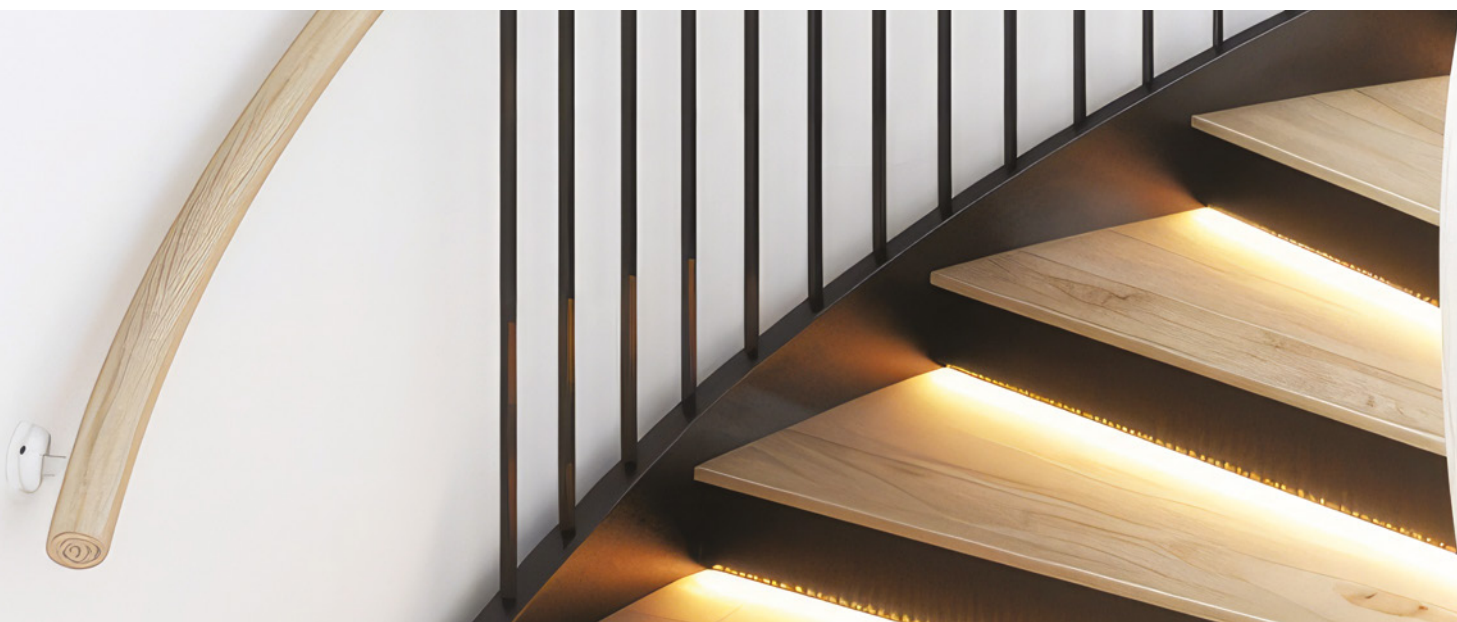

# DRŽALA ZA OGRAJO



DRŽALO ZA OGRAJO **KOVINA, INOX**

**STARMAN®**



Montaža okroglega ročaja s ploščico.



Montaža ravnega ročaja brez ploščice.

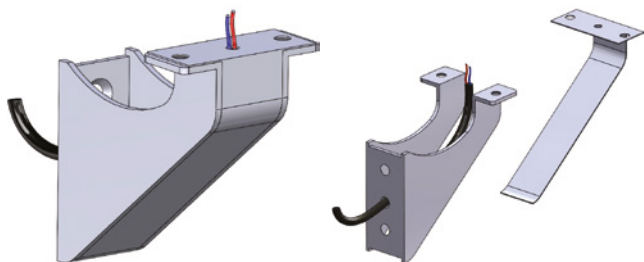

Po naročilu možnost montaže kabla za led luč (konzola + pokrov)

Šifra	Naziv	Obdelava
195379	Držalo za ograjo dvojno U 60/20	črna
195380	Držalo za ograjo dvojno U 60/20	bela
195381	Držalo za ograjo dvojno U 60/20	siva
195382	Držalo za ograjo dvojno U 60/20	antracit
195383	Držalo za ograjo dvojno U 60/20	inox

## LASTNOSTI:

- priložena ploščica za okrogle lesene ročaje
- možna montaža na gips plošče/stene s kovinskim vložkom

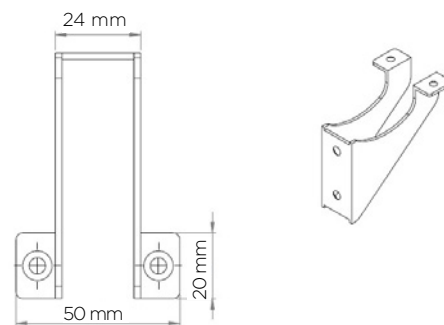
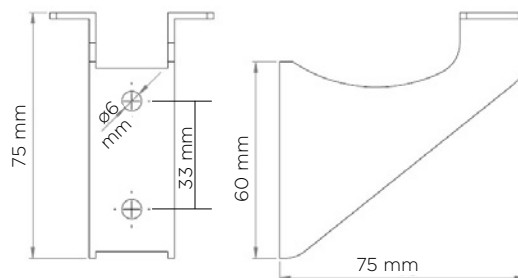



---

Tehnični opisi in mere v tem katalogu, tudi tiste s slikami in risbami niso zavezujoče. Pridružujemo si pravico do oblikovnih izboljšav. Ne prevzemamo odgovornosti za morebitne tiskarske napake ali druge napake, ki bi se lahko pojavile pri izdelavi kataloga.

Copyright: prepovedana je objava, predelava in kopiranje objavljenih vsebin, brez vednosti Starman d.o.o.

The technical descriptions and dimensions in this catalogue, also those with the photographs and drawings, are not binding. We reserve the right to make design improvements. We bear no liability for any misprints or other errors that might occur in the production of this catalogue.

Copyright: It is forbidden to publish, edit and copy published content without the knowledge of Starman d.o.o.

**Starman d.o.o.**  
**Poslovna cona Žeje pri Komendi**  
**Pod brezami 2, 1218 Komenda**  
**tel: +386 (0)1 724 79 00**  
**e-mail: [info@starman.si](mailto:info@starman.si)**  
**[www.starman.si](http://www.starman.si)**

## Pohištveni ročaji in obešalniki



Starman d.o.o.  
Poslovna cona Žeje pri Komendi  
Pod brezami 2  
1218 Komenda

tel: (0)1 724 79 00  
e-mail: [info@starman.si](mailto:info@starman.si)

[www.starman.si](http://www.starman.si)

Prelistaj tudi ostale kataloge  
našega prodajnega programa:



# STARMAN<sup>®</sup>